

# Window & Door Trim



- Crossheads ..... 18
- Pediments ..... 36
- Pilasters ..... 45
- Window Trim ..... 52
- Window Panels ..... 54
- Dormer Trim System ..... 54
- Keystones ..... 55
- Smooth Shutters ..... 56
- NEW** Smooth Shutter Board  
Fabrication Panels..... 62
- Wood-Grained Shutters..... 64
- Wood-Grained Shutter Board  
Fabrication Panels..... 80
- Shutter Accessories ..... 81

## AN UNFORGETTABLE FIRST IMPRESSION.

Transform the look of any home with Fypon® Window and Door Trim. Designed to work together, these pieces are quick and easy to install.

**Product Shown:**

- Flat Trim
- Dentil Blocks
- Distinction Crosshead
- Shaker-Style Shutters
- PremiumSelect Square Column Wraps with Raised Panels



# Window & Door Trim

## HOW TO USE THIS SECTION

Where applicable, part numbers are shown for products with attached accessories, or other available unattached accessories are referenced or shown with the product.

## HOW TO ORDER

### Door Trim & Entrance Systems

When ordering door trim, first measure the door unit to be trimmed. The unit can be measured with or without brickmould; however the brickmould is essential when using a storm door. Next, choose the desired pilaster style and size. Finally, choose a pediment or crosshead that is wide enough to span the opening plus the brickmould and pilasters or flat trim. Add desired accessories to complete the look.

### Window & Door Trim Accessories

Keystones, dentil trim, trim strip and bottom trim accessories are available attached to standard products as fabricated products. A keystone can also be ordered as an unattached accessory.



### How to Order Trimmable Crosshead

- 1 Determine height.
- 2 Determine breast board width of crosshead.
- 3 Select end cap width. End cap widths should coordinate with pilaster or moulding on either side of door / window. If no moulding is used, then any end cap can be selected.
- 4 Calculate trimmable crosshead; account for end cap. Crosshead breast board width - (end cap back surface x 2) = trimmable crosshead
- 5 Select trimmable crosshead.
- 6 Optional: Select accessory moulding / keystone.

### Example

6" high  
 36" width  
 CHC4X6 (Coordinating over 3-1/2" flat trim)  
 $36" - (2.5" \times 2) = 31"$  required\*  
 CHT36X6  
 K6M and MLD716-12

\*End cap back surface.

Note: Always consult the local building code authority to determine suitability of products to meet specific project requirements.

## WINDOW & DOOR TRIM APPLICATIONS

### Distinction Crosshead with End Caps



### Craftsman Cove Crosshead with End Caps

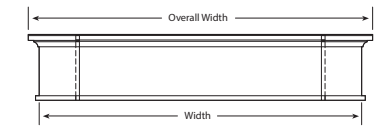

### Classic Crosshead without Accessories

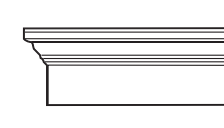

### Classic Crosshead with Accessories

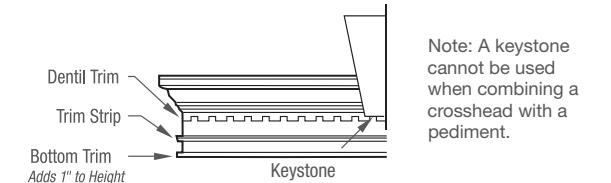

### Window Trim Terminology

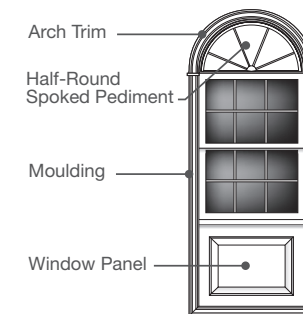

### Keystone Options



### Crosshead Options for Entry Way

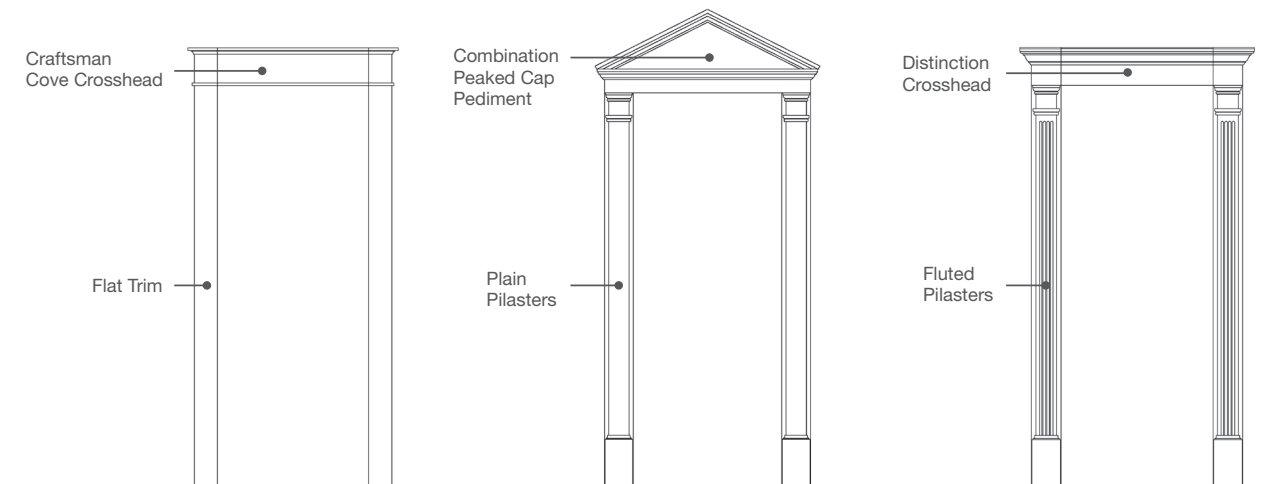

# DISTINCTION CROSSHEAD



## Ready-to-Install

- Our Distinction crosshead line includes heights measuring 6" and 9". Widths for 6" are 24" - 144", and widths for 9" are 24" - 216", both in 1" increments.
- End cap comes standard with 1-1/2" width and overlaps crosshead.

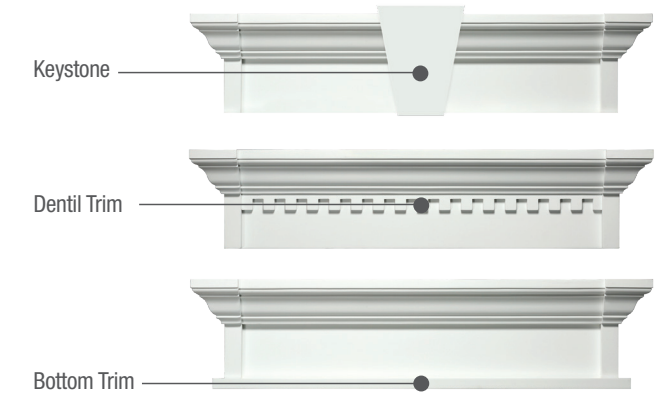

## 6" & 9" Distinction Crosshead

Ready-to-Install



Part Number Logic:

**CH24X6EC**

<b>[Profile]</b> CH = Crosshead	<b>[Breast Board Width]</b> (1" increments) 24 = 24" [Minimum] 144 = 144" [Maximum for 6" high] 216 = 216" [Maximum for 9" high]	<b>[Height]</b> 6 = 6" 7 = 7" (BT option only) 9 = 9" 10 = 10" (BT option only)	<b>[Configuration]</b> BT = Bottom Trim D = Dentil Trim K = Keystone R = Routed
------------------------------------	--	---	---

## Distinction Crosshead with Coordinating Pilaster Widths

Ready-to-Install

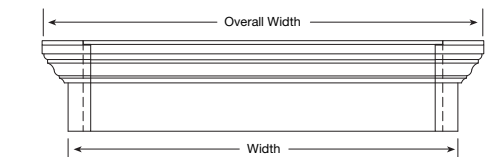

Part Number Logic:

**CH51X6EC5**

<b>[Profile]</b> CH = Crosshead	<b>[Pilaster Width*]</b> 5 = 5-1/4" 7 = 7" 9 = 9"	<b>[Crosshead Width]</b> (1" increments) 51 = 51" [Minimum] 96 = 96" [Maximum]	<b>[Crosshead Height]</b> 6 = 6" 9 = 9"	<b>[Configuration]</b> EC = End Cap
------------------------------------	--	---	---	--

If pilasters are to be included as part of the opening, remember the following:

- 1) Remember to account for lighting, door bells, mailboxes or any other item that could dictate the width of the pilaster.
- 2) Don't forget to take into account brickmould, if applicable
- 3) Breast board of crosshead should fit over the entire width of the right and left pilasters.

\*The last character in the part number coordinates with the pilaster width.

## Trimmable

- Distinction trimmable crossheads are available in heights measuring 6" and 9", and widths measuring 36", 48", 144" and 216".
  - 36" and 48" widths allow for ease of handling and quick installation.
  - 144" and 216" widths can be cut to any length, minimizing waste in the field.
- End caps overlap the trimmable crosshead.
- End caps may be routed.

### 6" & 9" Distinction Crosshead

Trimmable

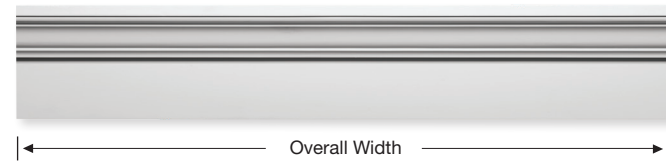

6" Height		9" Height		Overall Width
CHT36X6		CHT36X9		36"
CHT48X6		CHT48X9		48"
CHT144X6		CHT144X9		144- <sup>3</sup> / <sub>8</sub> "
CHT216X6		CHT216X9		216- <sup>5</sup> / <sub>8</sub> "

## End Caps



6" Height			9" Height			Breast Board Width (B)	Rabbit Width (C)
Qty 1	Qty 5	Overall Width (A)	Qty 1	Qty 5	Overall Width (A)		
CHC2X6	CHC2X6-5	3- <sup>1</sup> / <sub>4</sub> "	CHC2X9	CHC2X9-5	4- <sup>1</sup> / <sub>4</sub> "	1- <sup>1</sup> / <sub>2</sub> "	1/2"
CHC4X6	CHC4X6-5	5- <sup>1</sup> / <sub>4</sub> "	CHC4X9	CHC4X9-5	6- <sup>1</sup> / <sub>4</sub> "	3- <sup>1</sup> / <sub>2</sub> "	1"
CHC7X6*	CHC7X6-5*	8- <sup>3</sup> / <sub>4</sub> "	CHC7X9*	CHC7X9-5*	9- <sup>3</sup> / <sub>4</sub> "	7"	4"
CHC11X6*	CHC11X6-5*	12- <sup>3</sup> / <sub>4</sub> "	CHC11X9*	CHC11X9-5*	13- <sup>3</sup> / <sub>4</sub> "	11"	4"

Note: End caps are sold in pairs.  
\*Trimmable up to 3-<sup>1</sup>/<sub>2</sub>".



## Distinction Accessories

Accessory	6" Height	9" Height
 Keystone	K6M	K9M
 Dentil	MLD357-8	MLD358-8
 Bottom Trim	MLD716-12	MLD758-12

# CRAFTSMAN COVE CROSSHEAD



## Ready-to-Install

- Our expanded Craftsman Cove crosshead line includes heights measuring 9" and widths measuring 24" - 216", in 1" increments.
- End caps come standard with 3-1/2" width and overlap crosshead.
- End caps may be routed.

## 9" Craftsman Cove Crosshead



### Part Number Logic:

**CHCC24X9BTEC**

<b>[Profile]</b> CHCC = Craftsman Cove Crosshead	<b>[Breast Board Width]</b> (1" increments) 24 = 24" [Minimum] 216 = 216" [Maximum]	<b>[Configuration]</b> R = Routed EC = End Cap BT = Bottom Trim	<b>[Height]</b> 9 = 9"
---	--	--	---------------------------

If flat trim is to be included as part of the opening, remember the following:

- 1) Account for lighting, door bells, mailboxes or any other item that could dictate the width of the trim.
- 2) Don't forget to take into account brickmould, if applicable.
- 3) Breast board of the crosshead or crosshead end cap should fit over both the left and right trim pieces.





## Trimmable

- Our expanded Craftsman Cove crosshead line includes a 9" height, measuring 36", 48", 144" and 216".
- End caps do not come standard with trimmable product. They must be ordered. 3-1/2" or 5-1/2" end caps are optional; complement standard trim widths.
- End caps overlap crosshead.
- Crosshead and end caps may be routed.

## 9" Craftsman Cove Crosshead

Trimmable

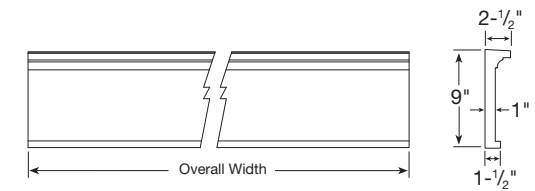

Part Number	Overall Width
CHCCT36X9BT	36"
CHCCT48X9BT	48"
CHCCT144X9BT	144"
CHCCT216X9BT	216"

## How to Order

- 1 Determine height.
- 2 Determine breast board width. When installing over side trim CHCCC6X9BT coordinates best with 5-1/4" pilaster and 5-1/2" wide trim.
- 3 Select end cap width.



## 9" Craftsman Cove End Caps

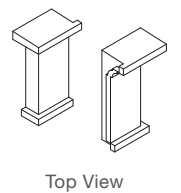
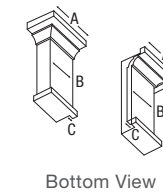

Part Number	Overall Width (A)	Width (B)	Rabbit Width (C)
CHCCC4X9BT	5"	3-1/2"	1/2"
CHCCC4X9BT-5*			
CHCCC6X9BT	7"	5-1/2"	1/2"
CHCCC6X9BT-5*			

\*Pack quantity of 5 pair.  
End cap overlaps the trimmable crosshead.

# CRAFTSMAN STEP CROSSHEAD



## 6" Craftsman Step Crosshead

Trimmable

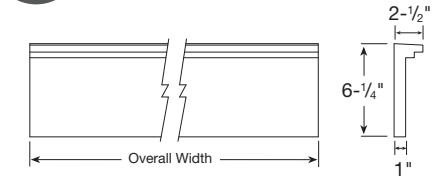

Part Number	Overall Width	Height
CHCST36X6	36"	6-1/4"
CHCST48X6	48"	6-1/4"
CHCST144X6	144-3/8"	6-1/4"
CHCST216X6	216-5/8"	6-1/4"

## 8" Craftsman Step Crosshead

Trimmable

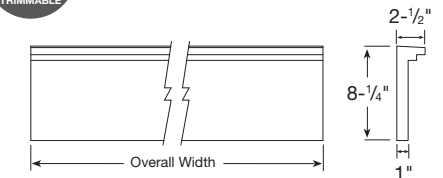

Part Number	Overall Width	Height
CHCST36X8	36"	8-1/4"
CHCST48X8	48"	8-1/4"
CHCST144X8	144-3/8"	8-1/4"
CHCST216X8	216-5/8"	8-1/4"



### PRO TIP

Fabricate trimmable crosshead to create mitered ends for a traditional look.

Note: Craftsman Step crossheads may be routed. Parts may be required to ship LTL (less than truckload) based on size and overall dimensions.

# CLASSIC CROSSHEAD



## 6" Classic Crosshead

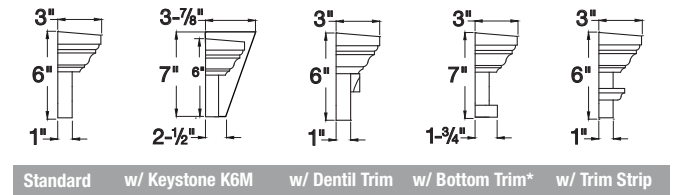
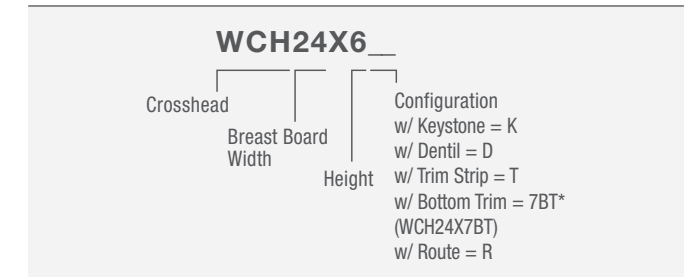

Part Number	Width	Overall Width
WCH24X6	24"	27-1/2"
WCH28X6	28"	31-1/2"
WCH30X6	30"	33-1/2"
WCH31X6	31"	34-1/2"
WCH32X6	32"	35-1/2"
WCH33X6	33"	36-1/2"
WCH34X6	34"	37-1/2"
WCH35X6	35"	38-1/2"
WCH36X6	36"	39-1/2"
WCH37X6	37"	40-1/2"
WCH38X6	38"	41-1/2"
WCH40X6	40"	43-1/2"
WCH41X6	41"	44-1/2"
WCH43X6	43"	46-1/2"
WCH44X6	44"	47-1/2"
WCH46X6	46"	49-1/2"
WCH47X6	47"	50-1/2"
WCH48X6	48"	51-1/2"
WCH50X6	50"	53-1/2"
WCH51X6	51"	54-1/2"
WCH52X6	52"	55-1/2"
WCH54X6	54"	57-1/2"
WCH56X6	56"	59-1/2"

Part Number	Width	Overall Width
WCH60X6	60"	63-1/2"
WCH64X6	64"	67-1/2"
WCH66X6	66"	69-1/2"
WCH67X6	67"	70-1/2"
WCH68X6	68"	71-1/2"
WCH72X6	72"	75-1/2"
WCH73X6	73"	76-1/2"
WCH74X6	74"	77-1/2"
WCH76X6	76"	79-1/2"
WCH78X6	78"	81-1/2"
WCH79X6	79"	82-1/2"
WCH80X6	80"	83-1/2"
WCH80.5X6	80-1/2"	84"
WCH84X6	84"	87-1/2"
WCH86X6	86"	89-1/2"
WCH87X6	87"	90-1/2"
WCH96X6	96"	99-1/2"
WCH100X6	100"	103-1/2"
WCH103X6	103"	106-1/2"
WCH104X6	104"	107-1/2"
WCH108X6	108"	111-1/2"
WCH110X6	110"	113-1/2"
WCH144X6	144"	147-1/2"

\*Bottom trim adds 1" to overall height.



## 9" Classic Crosshead



### Part Number Logic:

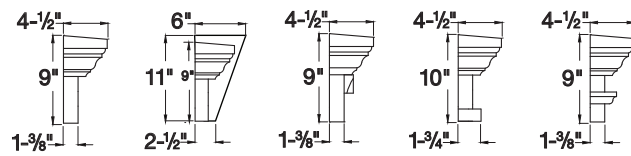
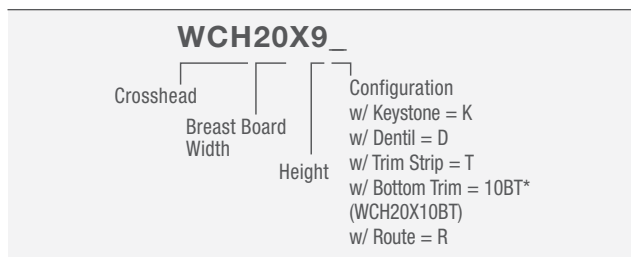

Standard    w/ Keystone K9M    w/ Dentil Trim    w/ Bottom Trim\*    w/ Trim Strip

Part Number	Width	Overall Width
WCH20X9	20"	25-1/2"
WCH24X9	24"	29-1/2"
WCH25X9	25"	30-1/2"
WCH26X9	26"	31-1/2"
WCH27X9	27"	32-1/2"
WCH28X9	28"	33-1/2"
WCH29X9	29-5/8"	35-1/8"
WCH30X9	30-1/4"	35-3/4"
WCH32X9	32"	37-1/2"
WCH33X9	33"	38-1/2"
WCH34X9	34"	39-1/2"
WCH35X9	35"	40-1/2"
WCH36X9	36"	41-1/2"
WCH37X9	37"	42-1/2"
WCH38X9	38"	43-1/2"
WCH40X9	40"	45-1/2"
WCH41X9	41"	46-1/2"
WCH42X9	42"	47-1/2"
WCH43X9	43"	48-1/2"
WCH44X9	44"	49-1/2"
WCH45X9	45"	50-1/2"
WCH46X9	46"	51-1/2"
WCH48X9	48"	53-1/2"
WCH49X9	49"	54-1/2"
WCH50X9	50"	55-1/2"
WCH54X9	54"	59-1/2"

Part Number	Width	Overall Width
WCH56X9	56"	61-1/2"
WCH58X9	58"	63-1/2"
WCH60X9	60"	65-1/2"
WCH62X9	62"	67-1/2"
WCH64X9	64"	69-1/2"
WCH65X9	65"	70-1/2"
WCH66X9	66"	71-1/2"
WCH67X9	67"	72-1/2"
WCH68X9	68"	73-1/2"
WCH69X9	69"	74-1/2"
WCH70X9	70"	75-1/2"
WCH72X9	72"	77-1/2"
WCH73X9	73"	78-1/2"
WCH74X9	74"	79-1/2"
WCH75X9	75"	80-1/2"
WCH76X9	76"	81-1/2"
WCH77X9	77"	82-1/2"
WCH78X9	78"	83-1/2"
WCH80X9	80"	85-1/2"
WCH81X9	81"	86-1/2"
WCH82X9	82"	87-1/2"
WCH84X9	84"	89-1/2"
WCH85X9	85"	90-1/2"
WCH86X9	86"	91-1/2"
WCH88X9	88"	93-1/2"
WCH90X9	90"	95-1/2"



## 9" Classic Crosshead

Part Number	Width	Overall Width
WCH93X9	93"	98-1/2"
WCH96X9	96"	101-1/2"
WCH99X9	99"	104-1/2"
WCH100X9	100"	105-1/2"
WCH101X9	101"	106-1/2"
WCH103X9	103"	108-1/2"
WCH104X9	104"	109-1/2"
WCH108X9	108"	113-1/2"
WCH110X9	110"	115-1/2"
WCH112X9	112"	117-1/2"

Part Number	Width	Overall Width
WCH113X9	113"	118-1/2"
WCH120X9	120"	125-1/2"
WCH124X9	124"	129-1/2"
WCH144X9	144"	149-1/2"
WCH192X9	192"	197-1/2"
WCH196X9	196"	201-1/2"
WCH197X9	197"	202-1/2"
WCH200X9	200"	205-1/2"
WCH204X9	204"	209-1/2"
WCH207X9	207"	212-1/2"

\*Bottom trim adds 1" to overall height.  
Parts may be required to ship LTL (less than truckload) based on size and overall dimensions.

Part Number Logic:

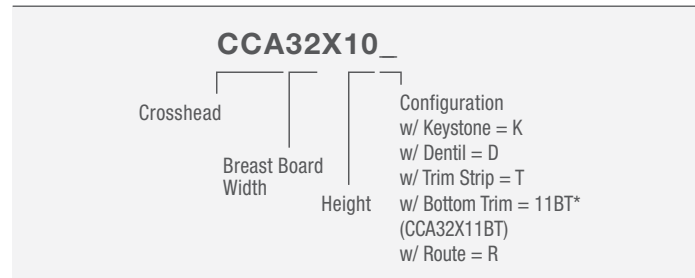

### 10" Classic Crosshead

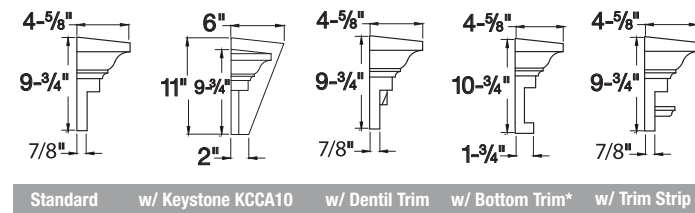

Part Number	Width	Overall Width
CCA32X10	32"	37-1/4"
CCA34X10	34"	39-1/4"
CCA36X10	36"	41-1/4"
CCA40X10	40"	45-1/4"
CCA47X10	47"	52-1/4"
CCA52X10	52"	57-1/4"
CCA64X10	64"	69-1/4"
CCA72X10	72"	77-1/4"
CCA100X10	100"	105-1/4"
CCA106X10	106"	111-1/4"
CCA199X10	199"	204-1/4"
CCA200X10	200"	205-1/4"

\*Bottom trim adds 1" to overall height.  
Parts may be required to ship LTL (less than truckload) based on size and overall dimensions.



Part Number Logic:

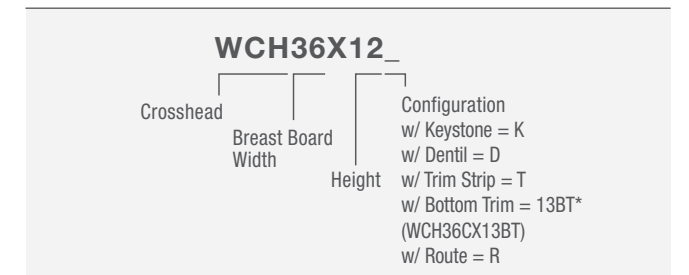

### 12" Classic Crosshead

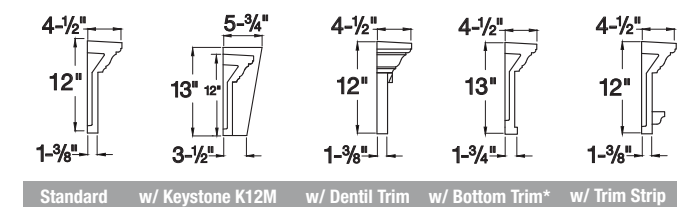
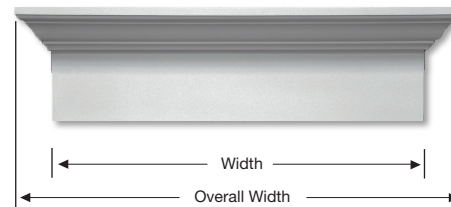

Part Number	Width	Overall Width
WCH36X12	36"	41-1/2"
WCH37X12	37-5/8"	43-1/8"
WCH40X12	40"	45-1/2"
WCH44X12	44"	49-1/2"
WCH48X12	48"	53-1/2"
WCH54X12	54"	59-1/2"
WCH56X12	56"	61-1/2"
WCH64X12	64"	69-1/2"

Part Number	Width	Overall Width
WCH72X12	72"	77-1/2"
WCH96X12	96"	101-1/2"
WCH102X12	102"	107-1/2"
WCH104X12	104"	109-1/2"
WCH144X12	144"	149-1/2"
WCH200X12	200"	205-1/2"
WCH203X12	203"	208-1/2"
WCH213X12	213"	218-1/2"

# 6" Crosshead Arch

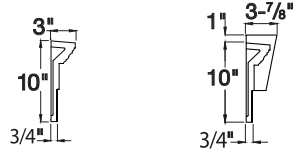
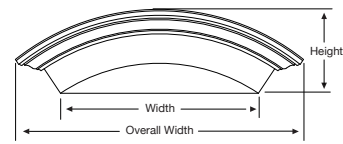
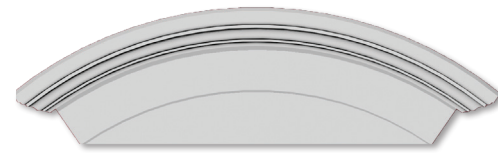

Standard w/ Keystone K6M

Part Number	Part Number w/ Keystone	Width	Overall Width	Height
WCH6ARS34X10	WCH6ARS34X10K	34"	42-7/8"	10"

### Part Number Logic:

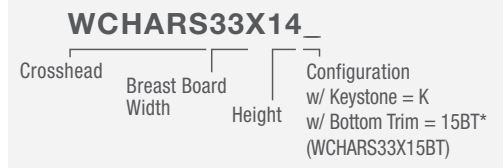

# 9" Crosshead Arch

Solid

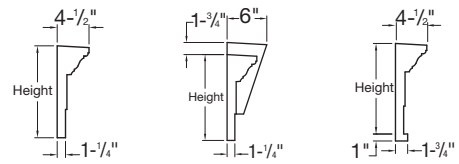
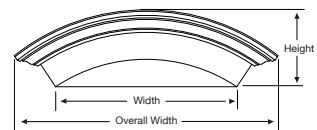

Standard w/ Keystone K9M w/ Bottom Trim\*

Part Number	Width	Overall Width	Height
WCHARS33X14	33"	48-1/8"	14"
WCHARS36X13	36"	49-1/4"	13"
WCHARS43X13	43"	55-1/4"	13"
WCHARS54X16	54"	68-1/8"	16"
WCHARS64X14	64"	75-1/2"	14"
WCHARS68X12	68"	77-1/4"	12"
WCHARS68X16	68"	80-7/8"	16"
WCHARS72X13	72"	82-1/8"	13"
WCHARS75X13	75"	84-7/8"	13-3/8"
WCHARS80X15	80"	91-1/4"	15"
WCHARS84X16	84"	95-3/4"	16"
WCHARS89X13	89"	98-3/8"	13"
WCHARS97X17	97"	108-3/4"	17"
WCHARS101X13	101"	110"	13"
WCHARS108X19	108"	119-7/8"	19-1/4"

\*Bottom trim adds 1" to overall height.

### Part Number Logic:

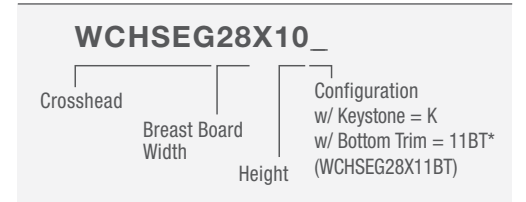

# 10" Eyebrow Crosshead

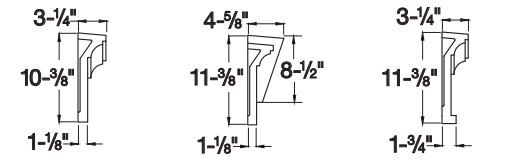
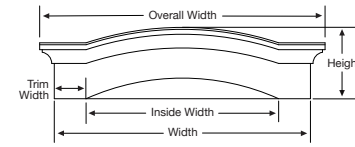

Standard w/ Keystone K10SEG w/ Bottom Trim\*

Part Number	Width	Inside Width	Overall Width
WCHSEG28X10	37-1/4"	28"	41-1/2"
WCHSEG30X10	39-1/8"	29-7/8"	43-3/8"
WCHSEG34X10	44"	34"	48-1/4"
WCHSEG36X10	45"	36"	49-1/4"
WCHSEG43X10	48"	43"	52-1/4"
WCHSEG44X10	49"	44"	53-1/4"
WCHSEG64X10	73-1/4"	64"	77-1/2"
WCHSEG72X10	81"	72"	85-1/4"

# Large Door Crosshead

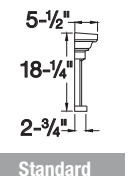
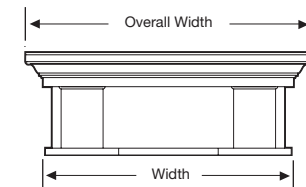

Standard

Part Number	Width	Overall Width	Pediment	Pilaster
LDCH58X18	58"	67-1/2"	AP667, PCP667, RHP667, SP667	All 11" Pilasters
LDCH62X18	62"	71-1/2"	AP667, PCP667, RHP667, SP667	
LDCH87X18	87"	96-1/2"	—	
LDCH90X18	90-1/2"	100"	RHP6100	
LDCH94X18	94-1/2"	104"	RHP6100	

Parts may be required to ship LTL (less than truckload) based on size and overall dimensions.

# Half-Round Spoked Pediment

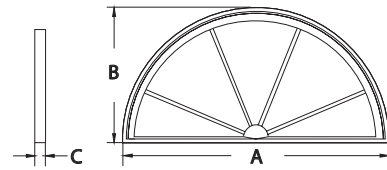

Keystone  
KWM180M Page 55

Part Number	Width (A)	Height (B)	Projection (C)	Flat Trim	Decorative Trim
HRSP36X18	36"	18"	1-3/4"	AR36X4F AR36X6F	AR36X4M, AR36X6M AR36X10MC
HRSP48X24	48"	24"	1-3/4"	AR48X4F AR48X6F	AR48X4M, AR48X6M
HRSP72X36	72"	36"	1-3/4"	AR72X4F	AR72X6M



# Half-Round Sunburst

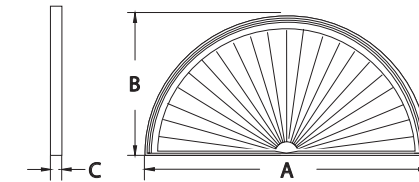

Keystone  
KWM180M Page 55

Part Number	Width (A)	Height (B)	Projection (C)	Flat Trim	Decorative Trim
SWDH24X12	24"	12"	1-3/4"	AR24X4F	—
SWDH28X14	28"	14"	1-3/4"	—	—
SWDH30X15	30"	15"	1-3/4"	—	—
SWDH32X16	32"	16"	1-3/4"	—	—
SWDH33X17	33-5/8"	16-3/4"	1-3/4"	—	—
SWDH36X18	36"	18"	1-3/4"	AR36X4F AR36X6F	AR36X4M, AR36X6M AR36X10MC
SWDH37X19	37-5/8"	18-3/4"	1-3/4"	AR37X4F	—
SWDH40X20	40"	20"	1-3/4"	—	AR40X6M DVP40
SWDH42X21	42"	21"	1-3/4"	—	—
SWDH44X22	44"	22"	1-3/4"	—	—
SWDH48X24	48"	24"	1-3/4"	AR48X4F AR48X6F	AR48X4M, AR48X6M
SWDH56X28	56"	28"	1-3/4"	—	—
SWDH60X30	60"	30"	1-3/4"	—	AR60X6M
SWDH64X32	64"	32"	1-3/4"	—	AR64X10MC
SWDH68X34	68"	34"	1-3/4"	—	—
SWDH72X36	72"	36"	1-3/4"	AR72X4F	AR72X6M
SWDH76X38	76"	38"	1-3/4"	—	—
SWDH100X50	100"	50"	1-3/4"	—	—

# Segment Sunburst

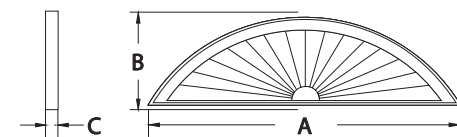

Keystone  
KWM180M Page 55

Part Number	Width (A)	Height (B)	Projection (C)
SWDH36X9	36"	9"	1-3/4"
SWDH40X10	40"	10"	1-3/4"
SWDH48X13	48"	13"	1-3/4"
SWDH68X14	67-5/8"	14"	1-3/4"
SWDH72X14	72"	14"	1-3/4"
SWDH76X15	76"	15"	1-3/4"
SWDH80X15	79-1/2"	15"	1-3/4"

# Elliptical Sunburst

with Decorative Trim

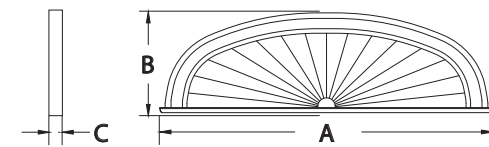

Part Number	Width (A)	Height (B)	Projection (C)
ESWDH76X23	76-7/8"	23"	3-1/2"

## Half-Round Sunburst

with Flat Trim &amp; Keystone

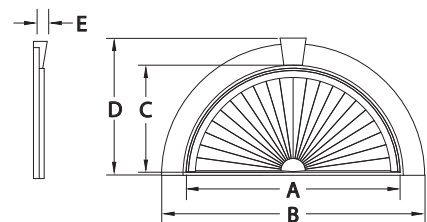
Flat Trim  
FLT152

Part Number	Width (A)	Overall Width (B)	Height (C)	Overall Height (D)	Projection (E)
SWDH36X18-4FK	36"	43"	18"	22-1/2"	2-1/4"

## Combination Sunburst Pediment

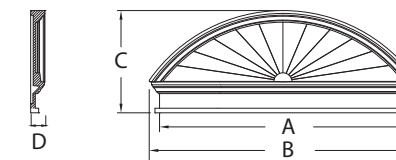
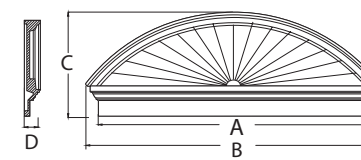

Part Number	Width (A)	Overall Width (B)	Height (C)	Projection (D)	Breast Board Thickness	Part Number w/ Bottom Trim*
CSP54	54"	58-1/2"	21-3/8"	3-1/8"	1"	CSP54BT
CSP75	75"	79-5/8"	23-3/4"	3-1/8"	1"	CSP75BT
CSP80	80"	84-5/8"	25-1/2"	3-1/8"	1"	CSP80BT
CSP85	85"	89-1/2"	26-3/8"	3-1/8"	1"	CSP85BT

## Sunburst Pediment

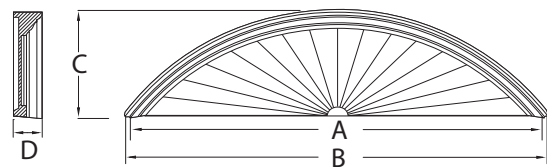

Part Number	Width (A)	Overall Width (B)	Height (C)	Projection (D)	Crosshead
SP56	55-1/4"	57"	16-3/4"	4-1/2"	WCH50X9
SP667	66-3/4"	69-1/4"	20-3/8"	5-1/2"	LDCH58X18 LDCH62X18
SP86	85-5/8"	87-1/4"	22-1/2"	4-1/2"	WCH81X9
SP91	90-1/2"	92-1/2"	26"	4-1/2"	WCH86X9

## Combination Segment Arch Pediment

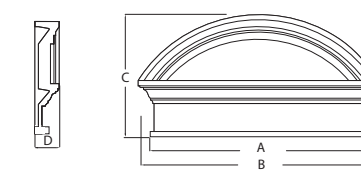
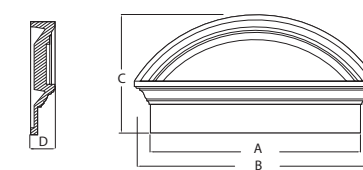

Part Number	Width (A)	Overall Width (B)	Height (C)	Projection (D)	Part Number w/ Bottom Trim*
CSAP36	36"	41-1/2"	20"	4-1/2"	CSAP36BT
CSAP48	48"	53-1/2"	22-1/2"	4-1/2"	CSAP48BT
CSAP65	65"	70-1/2"	28-3/8"	4-1/2"	CSAP65BT
CSAP84	84"	89-1/2"	28"	4-1/2"	CSAP84BT

\*Bottom trim adds 1" to overall height.  
Parts may be required to ship LTL (less than truckload) based on size and overall dimensions.

## Peaked Cap Pediment



Part Number	Overall Width (A)	Overall Height (B)	Projection (C)	Pitch (D)	Crosshead
PCP56	56-1/2"	13-5/8"	4-1/2"	5-1/2 / 12	WCH50X9
PCP667	68-3/4"	23-5/8"	5-1/2"	8 / 12	LDCH58X18 LDCH62X18

## Combination Peaked Cap Pediment

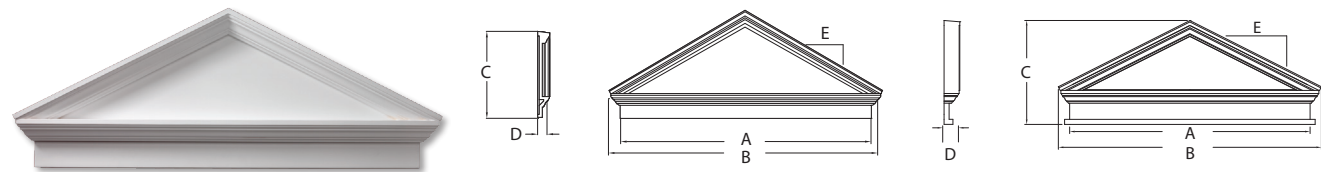

Part Number	Width (A)	Overall Width (B)	Overall Height (C)	Projection (D)	Pitch (E)	Breast Board Thickness	Part Number w/ Bottom Trim*
CPCP48	47-1/2"	52"	19-1/2"	3-1/8"	6 / 12	1"	CPCP48BT
CPCP50	50"	54-1/2"	20-1/4"	3-1/8"	6 / 12	1"	CPCP50BT
CPCP54	54"	58-1/4"	21"	3-1/8"	6 / 12	1"	CPCP54BT
CPCP58	58"	62-3/8"	22"	3-1/8"	6 / 12	1"	CPCP58BT
CPCP67	67-1/2"	72"	24-1/2"	3-1/8"	6 / 12	1"	CPCP67BT
CPCP75	75"	79-1/2"	26-1/4"	3-1/8"	6 / 12	1"	CPCP75BT
CPCP80	80"	84-1/2"	27-5/8"	3-1/8"	6 / 12	1"	CPCP80BT
CPCP85	85"	89-1/2"	28-3/4"	3-1/8"	6 / 12	1"	CPCP85BT



## Combination Peaked Cap Pediment

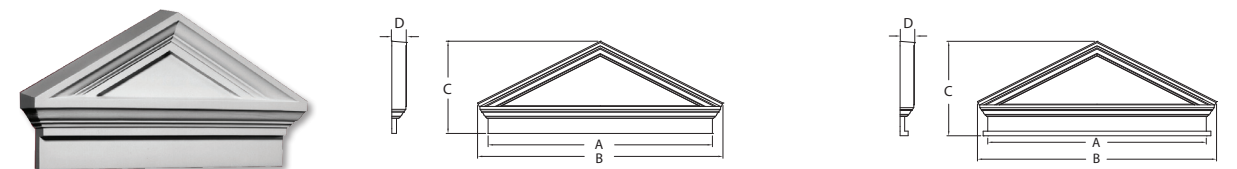

Part Number	Width (A)	Overall Width (B)	Height (C)	Projection (D)	Part Number w/ Bottom Trim*
CCP37	37-5/8"	41-3/4"	20-1/2"	4-1/2"	CCP37BT

\*Bottom trim adds 1" to overall height.  
Parts may be required to ship LTL (less than truckload) based on size and overall dimensions.

## Acorn Pediment



Note: Acorn ships unattached in carton.

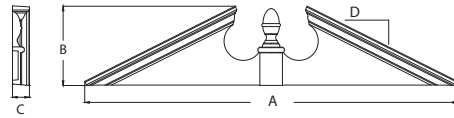

Part Number	Overall Width (A)	Overall Height (B)	Projection (C)	Pitch (D)	Crosshead
AP56	57"	16- <sup>5</sup> / <sub>8</sub> "	4- <sup>1</sup> / <sub>2</sub> "	6- <sup>1</sup> / <sub>2</sub> / 12	WCH50X9
AP61	62"	16- <sup>3</sup> / <sub>4</sub> "	4- <sup>1</sup> / <sub>2</sub> "	7 / 12	WCH54X9 WCH56X9
AP667	68- <sup>7</sup> / <sub>8</sub> "	23- <sup>1</sup> / <sub>4</sub> "	5- <sup>1</sup> / <sub>2</sub> "	12 / 12	LDCH58X18 LDCH62X18
AP86	87- <sup>1</sup> / <sub>4</sub> "	24"	4- <sup>1</sup> / <sub>2</sub> "	7 / 12	WCH81X9
AP91	92- <sup>1</sup> / <sub>8</sub> "	24- <sup>1</sup> / <sub>2</sub> "	4- <sup>1</sup> / <sub>2</sub> "	6 / 12	WCH86X9
AP98	99- <sup>1</sup> / <sub>8</sub> "	24- <sup>1</sup> / <sub>2</sub> "	4- <sup>1</sup> / <sub>2</sub> "	6 / 12	WCH90X9 WCH93X9

## Acorn Pediment

Adjustable



Note: Ships in 4 pieces.

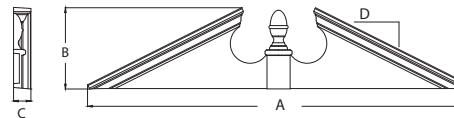

Part Number	Overall Width (A)	Overall Height (B)	Projection (C)	Pitch (D)	Crosshead
AP115	105"-115"	25- <sup>5</sup> / <sub>8</sub> "	4- <sup>1</sup> / <sub>2</sub> "	6 / 12	9" WCH from 100"-110"

## Combination Acorn Pediment



Note: Acorn ships unattached in carton.

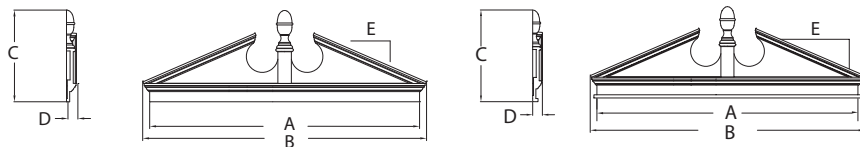

Part Number	Width (A)	Overall Width (B)	Overall Height (C)	Projection (D)	Pitch (E)	Part Number w/ Bottom Trim*
CAP47E**	47"	50- <sup>1</sup> / <sub>8</sub> "	13- <sup>5</sup> / <sub>8</sub> "	2- <sup>1</sup> / <sub>8</sub> "	5 / 12	—
CAP50	50"	54- <sup>1</sup> / <sub>2</sub> "	21- <sup>1</sup> / <sub>8</sub> "	3- <sup>1</sup> / <sub>8</sub> "	6 / 12	CAP50BT
CAP54	54"	58- <sup>1</sup> / <sub>2</sub> "	21- <sup>3</sup> / <sub>8</sub> "	3- <sup>1</sup> / <sub>8</sub> "	6 / 12	CAP54BT
CAP58	58"	62- <sup>1</sup> / <sub>2</sub> "	21- <sup>3</sup> / <sub>4</sub> "	3- <sup>1</sup> / <sub>8</sub> "	6 / 12	CAP58BT
CAP67	67- <sup>1</sup> / <sub>2</sub> "	72"	24- <sup>1</sup> / <sub>8</sub> "	3"	6 / 12	CAP67BT
CAP75	75"	79- <sup>1</sup> / <sub>2</sub> "	25- <sup>1</sup> / <sub>8</sub> "	3- <sup>1</sup> / <sub>8</sub> "	6 / 12	CAP75BT
CAP80	80"	84- <sup>7</sup> / <sub>16</sub> "	25- <sup>3</sup> / <sub>8</sub> "	3- <sup>1</sup> / <sub>8</sub> "	5- <sup>1</sup> / <sub>2</sub> / 12	CAP80BT
CAP85	85"	89- <sup>3</sup> / <sub>8</sub> "	28- <sup>3</sup> / <sub>4</sub> "	3- <sup>1</sup> / <sub>8</sub> "	5 / 12	CAP85BT

\*Bottom trim adds 1" to overall height.

\*\*Does not have breast board. Accessories cannot be added.

## Rams Head Pediment

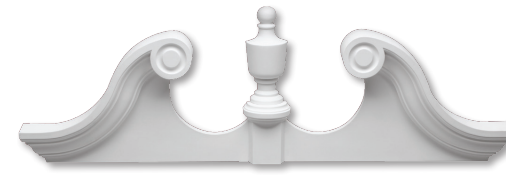

Note: Urn ships unattached in carton.

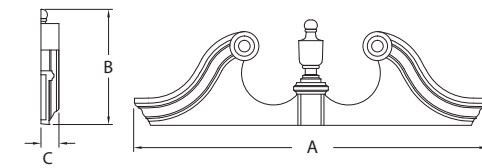

Part Number	Overall Width (A)	Overall Height (B)	Projection (C)	Crosshead
RHP56	60- <sup>7</sup> / <sub>8</sub> "	19- <sup>1</sup> / <sub>8</sub> "	4- <sup>1</sup> / <sub>2</sub> "	WCH50X9
RHP86	93- <sup>1</sup> / <sub>4</sub> "	29- <sup>1</sup> / <sub>2</sub> "	4- <sup>1</sup> / <sub>2</sub> "	WCH81X9

## Rams Head Pediment

with Decorative Trim

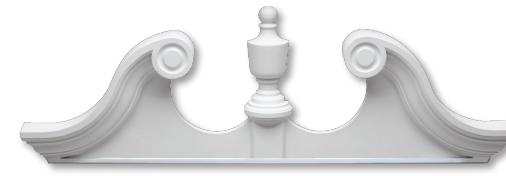

Note: Urn ships unattached in carton.

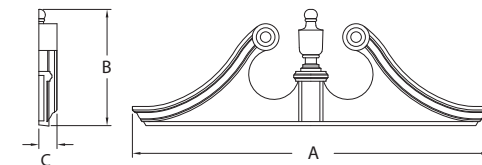

Part Number	Overall Width (A)	Overall Height (B)	Projection (C)	Crosshead
RHP667	73- <sup>1</sup> / <sub>2</sub> "	21- <sup>1</sup> / <sub>2</sub> "	5- <sup>1</sup> / <sub>2</sub> "	LDCH58X18 LDCH62X18
RHP6100	107- <sup>1</sup> / <sub>4</sub> "	29- <sup>3</sup> / <sub>8</sub> "	5- <sup>1</sup> / <sub>2</sub> "	LDCH90X18 LDCH94X18

## Combination Rams Head Pediment

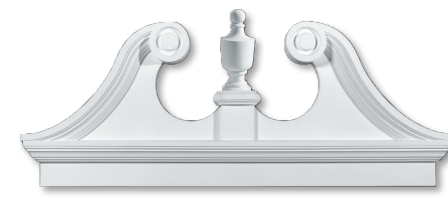

Note: Urn ships unattached in carton.

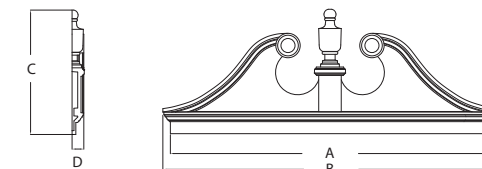

Part Number	Width (A)	Overall Width (B)	Overall Height (C)	Projection (D)	Breast Board Thickness	Part Number w/ Bottom Trim*
CRHP54	54"	58"	23- <sup>1</sup> / <sub>2</sub> "	3- <sup>1</sup> / <sub>8</sub> "	1"	CRHP54BT
CRHP67	67- <sup>1</sup> / <sub>2</sub> "	71- <sup>1</sup> / <sub>2</sub> "	27"	3- <sup>1</sup> / <sub>8</sub> "	1"	CRHP67BT
CRHP75	75"	79"	29- <sup>1</sup> / <sub>8</sub> "	3- <sup>1</sup> / <sub>8</sub> "	1"	CRHP75BT
CRHP80	80"	84"	35- <sup>3</sup> / <sub>4</sub> "	3- <sup>1</sup> / <sub>8</sub> "	1"	CRHP80BT
CRHP85	85"	89"	33- <sup>5</sup> / <sub>8</sub> "	3- <sup>1</sup> / <sub>8</sub> "	1"	CRHP85BT



## Deluxe Victorian Pediment



Part Number	Inside Width (A)	Inside Height	Overall Width (B)	Radius	Pitch (C)	Accessories
DVP40	40"	24-1/2"	67-1/4"	20"	7 / 12	PIL8X90P, PIL8X108P, SWDH40X20

## 7" Panel Arch

with Sunburst & Keystone

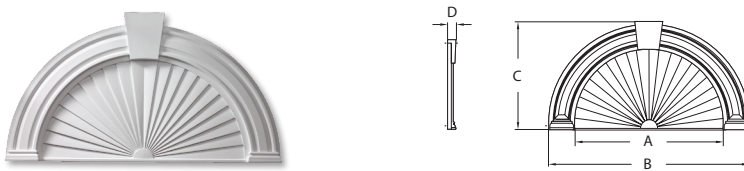

Part Number	Sunburst Width (A)	Overall Width (B)	Height (C)	Radius	Keystone Projection (D)	Pilaster
AR40X54PSK	40"	54"	29"	20"	2-5/8"	PIL7X90DP

Note: PIL7X90DP matches this arch profile only.

## 10" Decorative Arch

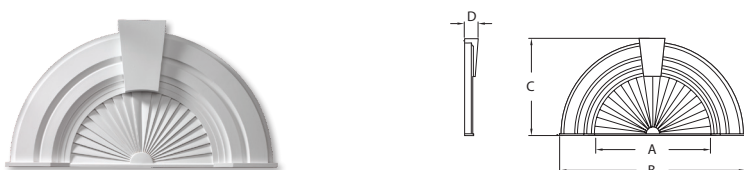

Part Number	Sunburst Width (A)	Overall Width (B)	Height (C)	Radius	Keystone Projection (D)	Pilaster
AR36X10SK	36"	56"	30-1/8"	2-1/8"	4"	PIL10X96A, PIL10X192A

Note: This arch matches PIL10X96A and PIL10X192A only.

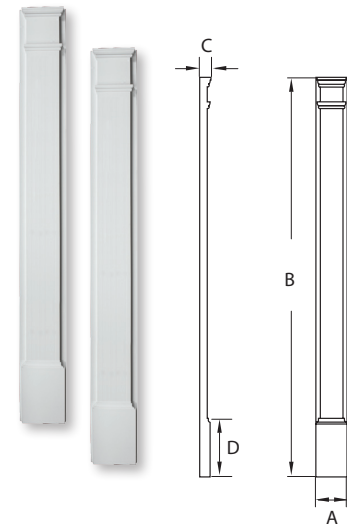

## Plain Pilaster

Molded with Plinth

Part Number	Width (A)	Height (B)	Projection (C)	Plinth Block Height (D)
PIL5X90P*	5-1/4"	90"	1-5/8"	10-1/8"
PIL6X90P*	6"	90"	2-1/2"	13-1/4"
PIL7X90P*	7"	90"	2-1/2"	13-1/4"
PIL8X90P*	8"	90"	2-1/2"	13-1/4"
PIL9X90P*	9"	90"	3"	14-1/2"
PIL11X90P*	11"	90"	3-1/2"	13-1/4"

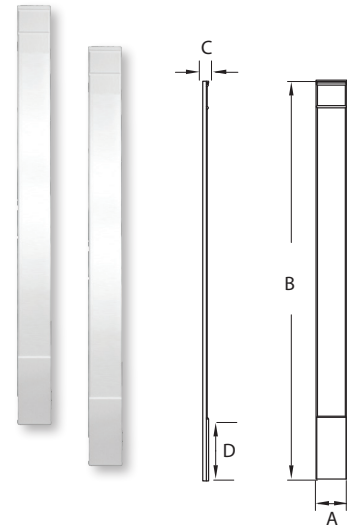

## Plain Narrow Pilaster

Molded with Plinth

Part Number	Width (A)	Height (B)	Projection (C)	Plinth Block Height (D)
PIL7X90PE*	7"	90"	1-1/4"	14-1/4"



\*Sold as a set. Pilaster may be routed for J-Channel.  
Parts may be required to ship LTL (less than truckload) based on size and overall dimensions.



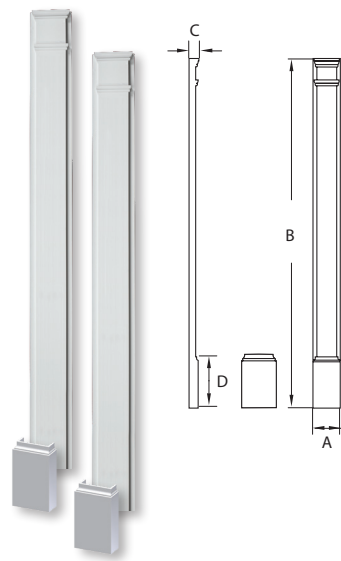

## Plain Pilaster

Two-Piece Adjustable

Part Number	Width (A)	Height (B)	Projection (C)	Plinth Block Height (D)
PIL5X108P*	5-1/4"	108"	1-5/8"	10"
PIL6X120P*	6"	120"	2-1/2"	13-1/4"
PIL7X108P*	7"	108"	2-1/2"	13"
PIL7X120P*	7"	120"	2-1/2"	13"
PIL8X108P*	8"	108"	2-5/8"	13"
PIL9X108P*	9"	108"	3"	14-1/2"
PIL9X120P*	9"	120"	3"	14-1/2"
PIL10X120P*	10"	120"	3-1/4"	14-1/2"
PIL11X96P*	11"	96"	3-1/2"	14-1/2"
PIL11X108P*	11"	108"	3-1/2"	14-1/2"
PIL11X109P*	11"	109"	3-1/2"	14-1/2"
PIL11X120P*	11"	120"	3-1/2"	14-1/2"

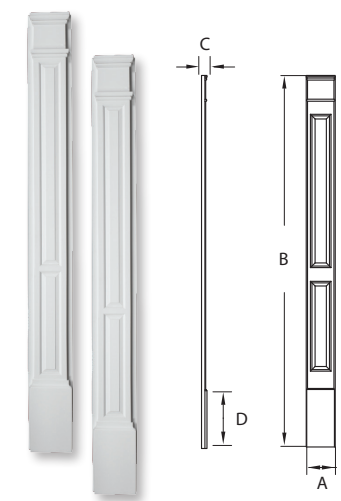

## Double Panel Pilaster

Molded with Plinth

Part Number	Width (A)	Height (B)	Projection (C)	Plinth Block Height (D)
PIL5X90DP*	5-1/4"	90"	1-5/8"	10-1/8"
PIL7X90DP*	7"	90"	2-1/2"	13-1/4"
PIL9X90DP*	9"	90"	3"	14-1/2"
PIL9X100DP*	9"	100"	3"	14-1/2"
PIL11X90DP*	11"	90"	3-1/2"	14-1/2"
PIL11X108DP*	11"	108"	3-1/2"	14-1/2"

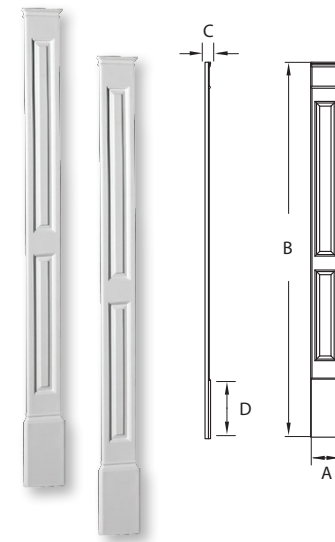

## Double Panel Narrow Pilaster

Molded with Plinth

Part Number	Width (A)	Height (B)	Projection (C)	Plinth Block Height (D)
PIL7X90DPE*	7"	90"	1-1/4"	14-1/4"

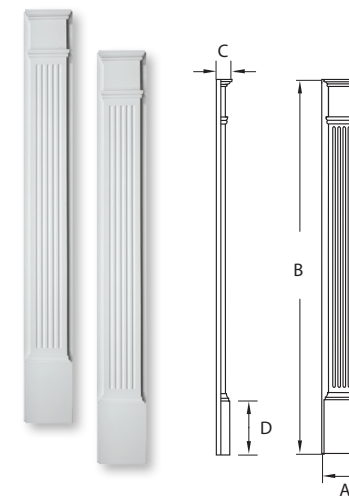

## Fluted Pilaster

Molded with Plinth

Part Number	Width (A)	Height (B)	Projection (C)	Plinth Block Height (D)
PIL3X81*	3-1/2"	81"	1-5/8"	10"
PIL4X83*	4-1/2"	82-3/4"	1-5/8"	7-3/4"
PIL4X86*	4-1/2"	86"	1-5/8"	11"
PIL4X90*	4-1/2"	90"	1-5/8"	10"
PIL5X82*	5-1/4"	82"	1-3/4"	8"
PIL5X90*	5-1/4"	90"	1-3/4"	10-1/8"
PIL6X90*	6-1/4"	90"	2-1/2"	13-1/4"
PIL7X90*	7"	90"	2-1/2"	13-1/4"
PIL9X90*	9"	90"	3"	14-1/2"
PIL11X90*	11"	90"	3-1/2"	14-1/2"

\*Sold as a set. Pilaster may be routed for J-Channel.  
Parts may be required to ship LTL (less than truckload) based on size and overall dimensions.

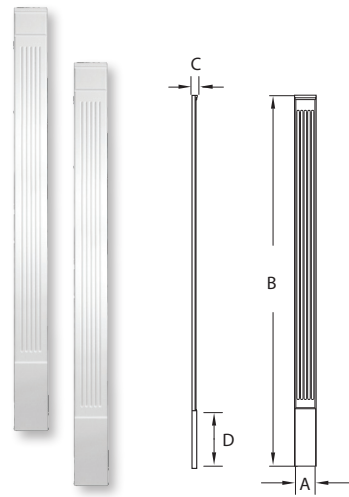

## Fluted Narrow Pilaster

Molded with Plinth

Part Number	Width (A)	Height (B)	Projection (C)	Plinth Block Height (D)
PIL3X90E*	3"	90"	1-1/4"	14-1/4"
PIL5X90E*	5-1/4"	90"	1-1/4"	14-1/4"
PIL7X90E*	7"	90"	1-1/4"	14-1/4"
PIL9X90E*	9"	90"	1-1/4"	14-1/4"

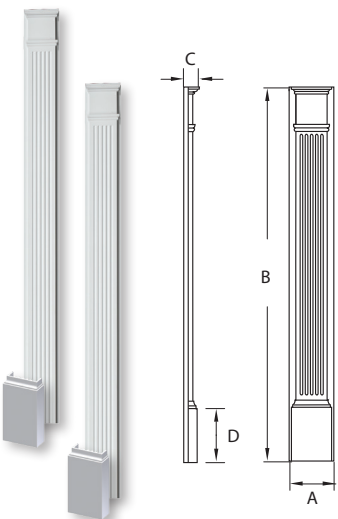

## Fluted Pilaster

Two-Piece Adjustable

Part Number	Width (A)	Height (B)	Projection (C)	Plinth Block Height (D)
PIL3X108*	3-1/2"	108"	1-5/8"	10"
PIL4X108*	4-1/2"	108"	1-5/8"	10"
PIL5X108*	5-1/4"	108"	1-5/8"	10"
PIL6X108*	6-1/4"	108"	2-1/2"	13-1/4"
PIL6X144*	6-1/4"	144"	2-1/2"	13-1/4"
PIL7X102*	7"	102"	2-1/2"	13-1/4"
PIL7X108*	7"	108"	2-1/2"	13"
PIL7X144*	7"	144"	2-1/2"	13"
PIL8X90*	8"	90"	2-1/2"	13"
PIL8X108*	8"	108"	2-1/2"	13"
PIL8X144*	8"	144"	2-1/2"	13"
PIL9X102*	9"	102"	3"	14-1/2"
PIL9X108*	9"	108"	3"	14-1/2"
PIL9X144*	9"	144"	3"	14-1/2"
PIL11X108*	11"	108"	3-1/2"	14-1/2"
PIL11X120*	11"	120"	3-1/2"	14-1/2"
PIL11X144*	11"	144"	3-1/2"	14-1/2"

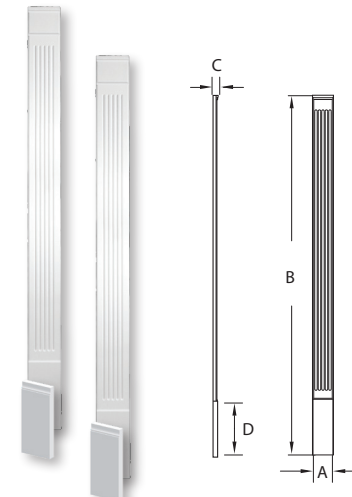

## Fluted Narrow Pilaster

Two-Piece Adjustable

Part Number	Width (A)	Height (B)	Projection (C)	Plinth Block Height (D)
PIL5X120E*	5-1/4"	120"	1-1/4"	14-1/4"
PIL7X120E*	7"	120"	1-1/4"	14-1/4"

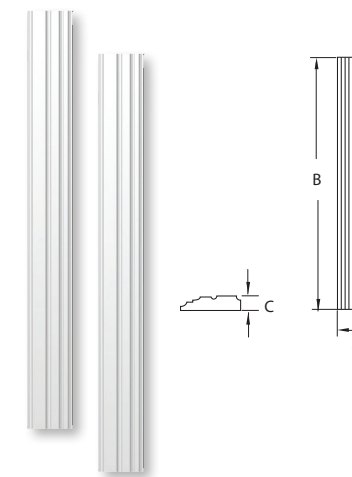

## Arch Profile Pilaster

Matches 10M Decorative Arches

Part Number	Width (A)	Height (B)	Projection (C)
PIL10X96A*	10"	96"	2-3/8"
PIL10X192A*	10"	192"	2-3/8"

Note: See page 44 for matching arches.

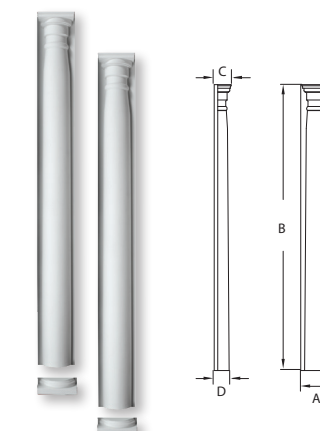

## Half-Round Pilaster

Adjustable Column

Part Number	Width (A)	Shaft Height** (B)	Top Projection (C)	Bottom Projection (D)
PIL10X96HC*	10"	93-5/8"	4-7/8"	5-1/2"

\*\*Overall height is adjustable from 80"-96". Shaft sits on top of plinth, which is 3" in height.

\*Sold as a set. Pilaster may be routed for J-Channel.  
Parts may be required to ship LTL (less than truckload) based on size and overall dimensions.

## Fluted Panel Trim

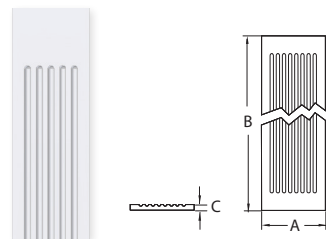

Part Number	Width (A)	Height (B)	Projection (C)
FP9X168	8-1/2"	168"	1-1/4"
FP12X96	12"	96"	1-1/2"

\*Actual product has flutes running the full length on this size only.



## Half-Round Arch Trim

4F Flat

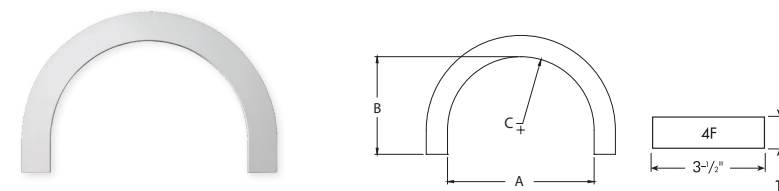

### Accessories

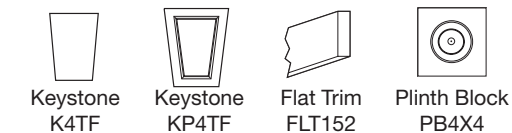

Part Number	Inside Width (A)	Inside Height (B)	Radius (C)
AR24X4F	24-1/8"	16-1/8"	12-1/8"
AR36X4F	36"	22"	18"
AR37X4F	37-5/8"	22-3/4"	18-3/4"
AR48X4F	48"	28"	24"
AR72X4F	72"	40"	36"

Note: This part uses keystones K4TF and KP4TF only.

## Half-Round Arch Trim

4M Decorative

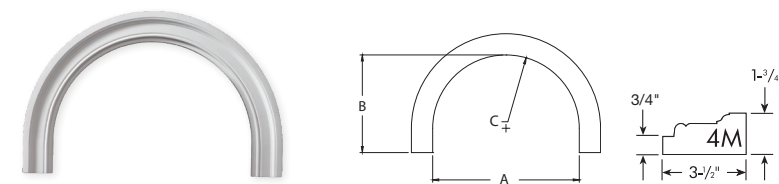

### Accessories



Part Number	Inside Width (A)	Inside Height (B)	Radius (C)
AR36X4M	36"	22"	18"
AR48X4M	48"	28"	24"

Note: This part uses keystones K4TM and KP4TM only.

# Half-Round Arch Trim

6F Flat

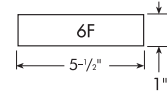
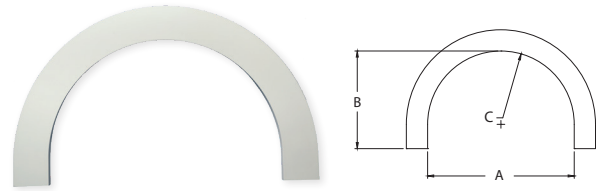

### Accessories

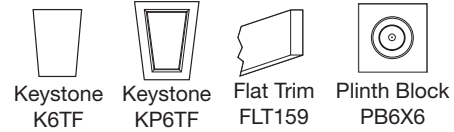

Part Number	Inside Width (A)	Inside Height (B)	Radius (C)
AR36X6F	36"	22"	18"
AR48X6F	48"	28"	24"

Note: This part uses keystones K6TF and KP6TF only.

# Half-Round Arch Trim

6M Decorative

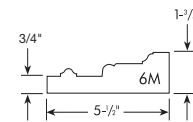
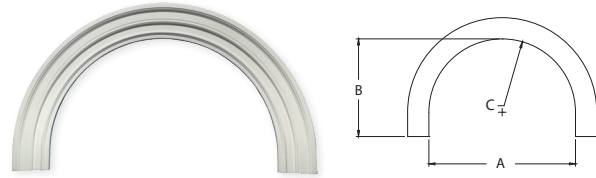

### Accessories



Part Number	Inside Width (A)	Inside Height (B)	Radius (C)
AR36X6M	36"	21"	18-1/8"
AR40X6M	40"	24"	20"
AR48X6M	48"	28"	24"
AR60X6M	60"	34"	30"
AR72X6M	72"	40"	36"

Note: This part uses keystones K6TM and KP6TM only.

# Half-Round Arch Trim

10M Decorative

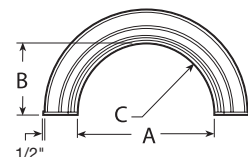
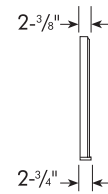

### Accessories

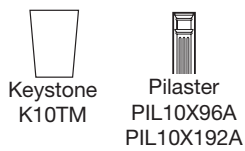

Part Number	Inside Width (A)	Inside Height (B)	Radius (C)
AR36X10MC	36"	18-3/4"	18"
AR64X10MC*	64"	32-3/4"	32"

\*Part ships in two pieces and will need to be trimmed in field to fit.

# Half-Round Arch with Flankers

10M Decorative

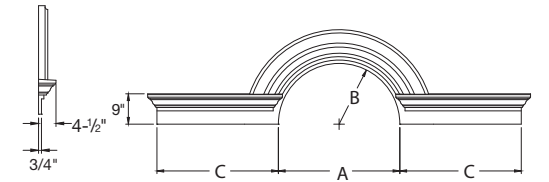

Part Number	Inside Width (A)	Inside Height / Radius (B)	Flanker Width (C)	Overall Width (D)	Accessories
AR36X10MFL108	36"	18"	36"	108"	K10TM SWDH36X18

# Circle Trim

4F Flat

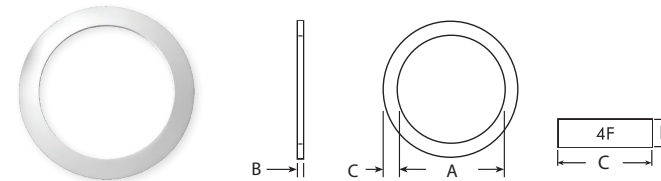

Part Number	Inside Width (A)	Projection (B)	Trim Width (C)
CIR24X4F	24-1/4"	1"	3-1/2"
CIR36X4F	36-1/8"	1"	3-1/2"

# Oval Trim

4F Flat

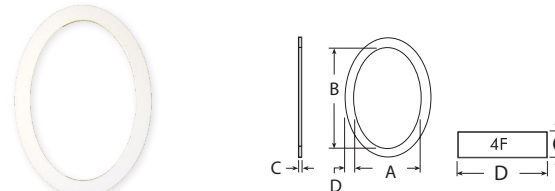

Part Number	Inside Width (A)	Inside Height (B)	Projection (C)	Trim Width (D)
OV24X36X4F	24-1/8"	36-1/8"	1"	3-1/2"

# Oval Trim

4M Decorative

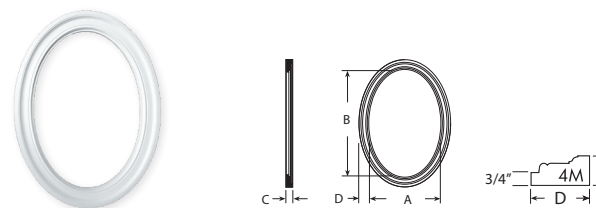

Part Number	Inside Width (A)	Inside Height (B)	Projection (C)	Trim Width (D)
OV24X36X4M	24-1/8"	36-1/8"	1-3/4"	3-1/2"

Parts may be required to ship LTL (less than truckload) based on size and overall dimensions.

## Window Panel

Flat Panel

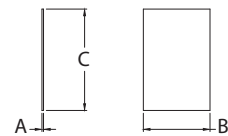

Part Number	Thickness (A)	Width (B)	Height (C)
FLT40X96*	1"	40"	96"
WDP48X73F	1-1/8"	48"	73"

\*Can also be found on page 87 under Flat Trim.

## Window Panel

Raised Panel

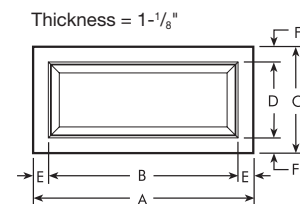

Part Number	Overall Width (A)	Panel Width (B)	Overall Height (C)	Panel Height (D)	Border Width (E)	Border Height (F)
WDP36X18	36"	28"	18"	10"	4"	4"

## Dormer Trim System

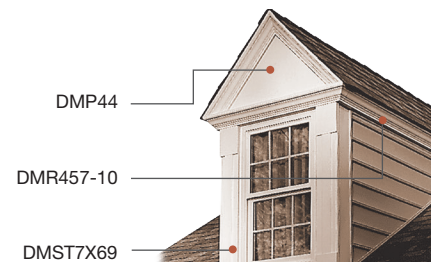

Dormer Trim System

	Part Number	Width (A)	Overall Width (B)	Overall Height (C)	Projection (D)	Pitch (E)
	DMP44 Pediment	43-3/4"	49-1/4"	33-1/4"	4-1/2"	14 / 12
	DMST7X69 Side Trim Set	6-3/4"	—	68-5/8"	1-1/2"	—
	DMR457-10 Return	—	—	—	—	—

## Keystones

for Trim Profiles

	Part Number	Top Width (A)	Bottom Width (B)	Height (C)	Top Projection (D)	Bottom Projection (E)	Arches & Trim
	K6*	4-3/4"	2-3/4"	6-1/2"	2-1/4"	1-5/8"	—
	K8*	9-3/4"	5-3/4"	7-3/4"	2-1/4"	1-1/4"	—
	K6M	5-3/4"	4"	7"	3-7/8"	1-1/2"	6" WCH, 6" WCH w/ BT 6" CH, 6" CH w/ BT
	K9M	8"	6"	11"	6-1/8"	1-1/8"	9" WCH, 9" WCH w/ BT 9" CH, 9" CH w/ BT
	K12M	8-1/2"	6"	13"	5-3/4"	2-1/8"	12" WCH
	K10SEG	8"	6"	8-1/2"	4-5/8"	3/4"	10" WCHSEG
	KCCA10	8"	6"	11"	6"	1-1/8"	10" CCA
	KP6M	5-3/4"	4"	7"	4-1/8"	1-3/4"	6" WCH, 6" WCH w/ BT 6" CH, 6" CH w/ BT
	KP9M	8"	6"	11"	6-1/4"	1-5/8"	9" WCH, 9" WCH w/ BT 9" CH, 9" CH w/ BT
	K4TF	4-1/4"	3"	4-1/2"	2-1/4"	1/2"	4F Arches FLT152
	K6TF	6"	4"	7"	2-3/8"	5/8"	6F Arches FLT159
	K8TF	7"	5"	8-7/8"	2-1/2"	3/4"	FLT162
	K4TM	4-1/4"	3"	4-1/2"	2-1/4"	3/4"	4M Arches MLD215
	K6TM	6"	4"	7"	2-3/8"	7/8"	6M Arches MLD220 DWH221
	K10TM	8"	5-1/2"	11-1/2"	4"	1-3/4"	10M Arch Trim PIL10X96A PIL10X192A
	KP4TF	4-1/4"	3"	4-1/2"	2-1/4"	1/2"	4F Arches FLT152
	KP6TF	6"	4"	7"	2-3/8"	5/8"	6F Arches FLT159
	KP4TM	4-1/4"	3"	4-1/2"	2-3/4"	3/4"	4M Arch Trim MLD215
	KP6TM	6"	4"	7"	2-1/2"	7/8"	6M Arch Trim MLD220 DWH221
	KWM180M	2-3/4"	2"	3-1/8"	2-1/2"	—	Brick Mould Louvers / Trim MLDWM180

\*Keystones K6 and K8 are not molded on back side.  
Parts may be required to ship LTL (less than truckload) based on size and overall dimensions.

## Louvered Shutter

with Center Rail

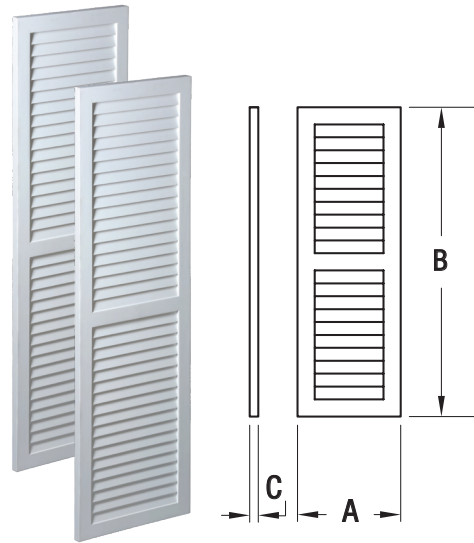

Part Number	Width (A)	Height (B)	Projection (C)
LVSH12X36FNCR	12"	36"	1"
LVSH12X48FNCR	12"	48"	1"
LVSH16X54FNCR	16"	54"	1"
LVSH16X60FNCR	16"	60"	1"
LVSH16X72FNCR	16"	72"	1"
LVSH18X60FNCR	18"	60"	1"
LVSH18X66FNCR	18"	66"	1"
LVSH18X72FNCR	18"	72"	1"
LVSH24X60FNCR	24"	60"	1"
LVSH24X72FNCR	24"	72"	1"

## Louvered Shutter

without Center Rail

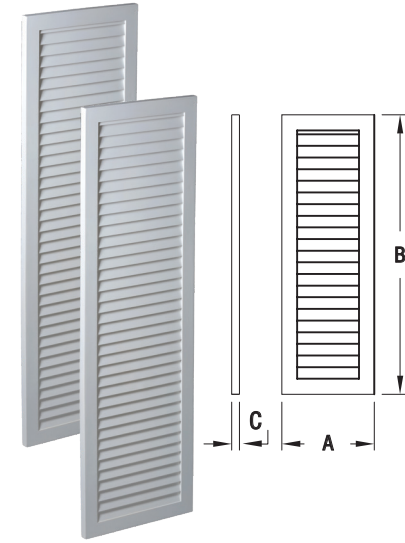

Part Number	Width (A)	Height (B)	Projection (C)
LVSH16X54FNB	16"	54"	1"
LVSH16X72FNB	16"	72"	1"
LVSH18X54FNB	18"	54"	1"
LVSH18X60FNB	18"	60"	1"
LVSH18X72FNB	18"	72"	1"
LVSH24X60FNB	24"	60"	1"
LVSH24X72FNB	24"	72"	1"

## Raised Panel Shutter

Double Panel

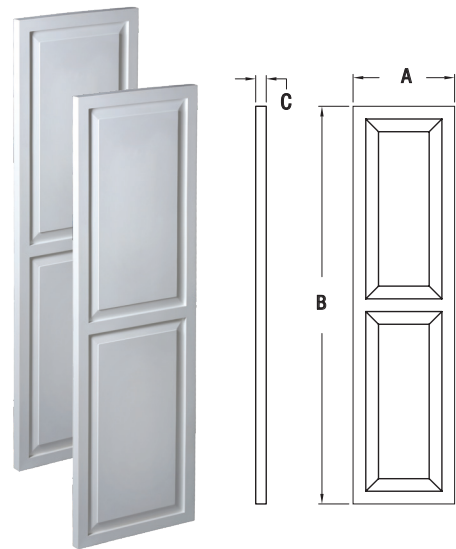

Part Number	Width (A)	Height (B)	Projection (C)
SH16X48DP	16"	48"	1-1/4"
SH16X54DP	16"	54"	1-1/4"
SH16X60DP	16"	60"	1-1/4"
SH16X65DP	16"	65"	1-1/4"
SH16X72DP	16"	72"	1-1/4"
SH18X53DP	18"	53"	1-1/4"
SH18X59DP	18"	59"	1-1/4"
SH18X66DP	18"	66"	1-1/4"
SH18X72DP	18"	72"	1-1/4"



# Modern Farmhouse Shaker-Style Shutters

- Available in widths measuring 12", 16", 18" and 24", and heights measuring 24" - 120" in 1" increments.
- 2" wide stiles and 2-1/2" wide batten create the X-batten design.
- Stiles 1-3/8" deep with 5/8" recessed panel.
- Shaker-style shutter panels and flat trim are available to create your own farmhouse design, details on page 62.

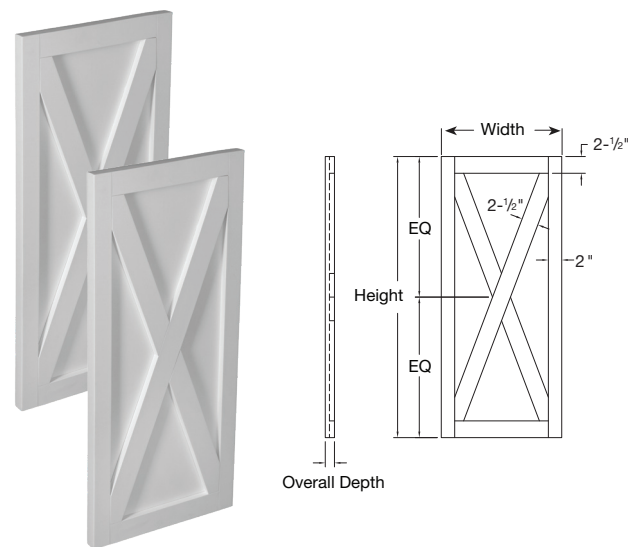

Part numbers shown reflect common sizes.  
For additional options, follow the part number logic below or contact your Fypon® representative.

**SHMFH12X24**

<b>[Profile]</b> SH = Shutter	<b>[Width]</b> 12 = 12" 16 = 16" 18 = 18" 24 = 24"	<b>[Height]</b> (1" Increments) 24 = 24" [Minimum] 120 = 120" [Maximum]
<b>[Configuration]</b> MFH = Modern Farmhouse style		

12"	16"	18"	24"
SHMFH12X24	SHMFH16X24	SHMFH18X24	SHMFH24X24
SHMFH12X36	SHMFH16X36	SHMFH18X36	SHMFH24X36
SHMFH12X48	SHMFH16X48	SHMFH18X48	SHMFH24X48
SHMFH12X60	SHMFH16X60	SHMFH18X60	SHMFH24X60
SHMFH12X72	SHMFH16X72	SHMFH18X72	SHMFH24X72
SHMFH12X84	SHMFH16X84	SHMFH18X84	SHMFH24X84
SHMFH12X96	SHMFH16X96	SHMFH18X96	SHMFH24X96
SHMFH12X108	SHMFH16X108	SHMFH18X108	SHMFH24X108
SHMFH12X120	SHMFH16X160	SHMFH18X180	SHMFH24X240



Note: Shutters are sold as a set.  
Parts may be required to ship LTL (less than truckload) based on size and overall dimensions.



## Shaker-Style Shutters

- 2-flat panel recessed stile and rail design.
- Available in widths measuring 12", 16", 18" and 24", and heights measuring 24" - 120" in 1" increments.
- 2" wide stiles with 2-1/2" wide rails. Center rail is positioned in the center of the shutter.
- Stiles 1-3/8" deep with 5/8" recessed panel.
- Shaker-style shutter panels and flat trim are available to create your own Craftsman design, details on page 62.

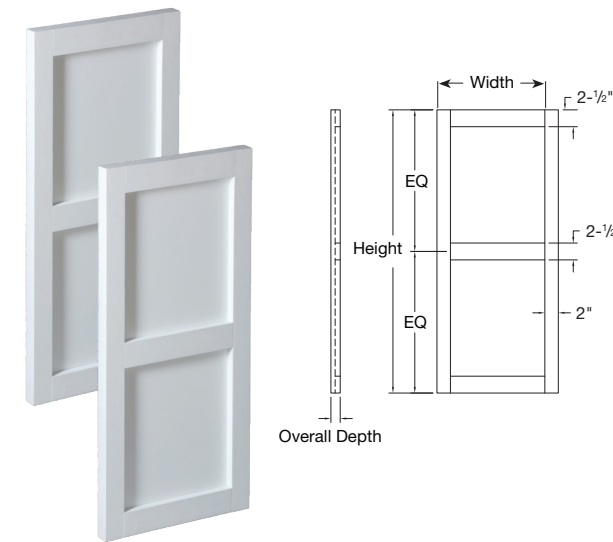

Part numbers shown reflect common sizes. For additional options, follow the part number logic below or contact your Fypon® representative.

SH2FP12X24		
[Profile] SH = Shutter		
[Configuration] 2FP = 2-Flat Panel	[Width] 12 = 12" 16 = 16" 18 = 18" 24 = 24"	[Height] (1" Increments) 24 = 24" [Minimum] 120 = 120" [Maximum]

12"	16"	18"	24"
SH2FP12X24	SH2FP16X24	SH2FP18X24	SH2FP24X24
SH2FP12X36	SH2FP16X36	SH2FP18X36	SH2FP24X36
SH2FP12X48	SH2FP16X48	SH2FP18X48	SH2FP24X48
SH2FP12X60	SH2FP16X60	SH2FP18X60	SH2FP24X60
SH2FP12X72	SH2FP16X72	SH2FP18X72	SH2FP24X72
SH2FP12X84	SH2FP16X84	SH2FP18X84	SH2FP24X84
SH2FP12X96	SH2FP16X96	SH2FP18X96	SH2FP24X96
SH2FP12X108	SH2FP16X108	SH2FP18X108	SH2FP24X108
SH2FP12X120	SH2FP16X160	SH2FP18X180	SH2FP24X240

Note: Shutters are sold as a set. Parts may be required to ship LTL (less than truckload) based on size and overall dimensions.



NEW

# Shutter Board Fabrication Panels

For Shaker-style and Modern Farmhouse Shaker-style Shutters

	Individual Sheet Part Number	Width	Length	Thickness
	SHSFP12X144	12"	144"	1-3/8"
	SHSFP16X144	14"	144"	1-3/8"
	SHSFP18X144	18"	144"	1-3/8"
	SHSFP24X144	24"	144"	1-3/8"
	FLT1X3-12	2-1/2"	144"	3/4"



# WOOD-GRAINED SHUTTERS

## Get the size and style you need.

- Our expanded line includes multiple styles and sizes, with widths measuring 12", 14", 18", and 24", and heights measuring 24"- 120" in 1" increments.
- Accessory line of hinges and clavos creates a distinct look for your shutters.
- Available in both Board & Batten and Plank styles.

### BOARD & BATTEN – JOINED BOARD AND BATTEN STYLES



**2 OR 3 BATTEN**  
Batten styles with joined boards.



**END BATTEN**  
Battens are placed at the very end of the boards.



**Z BATTEN**  
Horizontal and diagonal battens form Z shape.



**QUARTER ROUND**  
Mirrors unique arch top windows.



**ELLIPTICAL**  
Mirrors the shape of unique elliptical windows.

### PLANK – SPACED BOARDS CREATE VISIBILITY OF SIDING BETWEEN SHUTTER BOARDS



**2 OR 3 BATTEN**  
Batten styles with spaced boards.



**Z BATTEN**  
Horizontal and diagonal battens form Z shape.



**DIAMOND**  
Decorative diamond shape is centered between the panels.



**ELLIPTICAL**  
Mirrors the shape of unique elliptical windows.

#### Board & Batten Part Number Logic:

#### Plank Part Number Logic:

SH3PC18X60RS				SH3PO18X60RS			
[Profile]		[Texture]		[Profile]		[Texture]	
SH = Shutter		RS = Rough Sawn Stain or Paint		SH = Shutter		RS = Rough Sawn Stain or Paint	
[Configuration]				[Configuration]			
2PC = 2-Board, 2-Batten	2PZC = 2-Board, Z-Batten	[Height] (1" increments)		2PO = 2-Plank, 2-Batten	2PZ = 2-Plank, Z-Batten	[Height] (1" increments)	
3PC = 3-Board, 2-Batten	3PZC = 3-Board, Z-Batten	24 = 24" [Minimum]	120 = 120" [Maximum]	3PO = 3-Plank, 2-Batten	3PZ = 3-Plank, Z-Batten	24 = 24" [Minimum]	120 = 120" [Maximum]
4PC = 4-Board, 2-Batten	4PZC = 4-Board, Z-Batten	[Width]		4PO = 4-Plank, 2-Batten	4PZ = 4-Plank, Z-Batten	[Width]	
2P3BC = 2-Board, 3-Batten	2PEBC = 2-Board, End Batten	12 = 12"	14 = 14"	2P3B = 2-Plank, 3-Batten	2PD = 2-Plank, Diamond	12 = 12"	18 = 18"
3P3BC = 3-Board, 3-Batten	3PEBC = 3-Board, End Batten	14 = 14"	18 = 18"	3P3B = 3-Plank, 3-Batten	3PD = 2-Plank, Diamond	18 = 18"	24 = 24"
4P3BC = 4-Board, 3-Batten	4PEBC = 4-Board, End Batten	18 = 18"	24 = 24"	4P3B = 4-Plank, 3-Batten	4PD = 2-Plank, Diamond	24 = 24"	

#### Quarter Round Part Number Logic:

SH3PHLR18X60RS		
[Profile]	[Texture]	
SH = Shutter	RS = Rough Sawn Stain or Paint	
[Configuration]		
2PHLR = 2-Board Quarter	[Height] (1" increments)	
3PHLR = 3-Board Quarter	24 = 24" [Minimum]	120 = 120" [Maximum]
4PHLR = 4-Board Quarter	[Width]	
	12 = 12"	14 = 14"
	18 = 18"	24 = 24"

Note: Minimum height for Quarter Round shutters is double the width of the shutter.  
Example: SH3PHLR18x36RS – 18" = width of shutter and 36" = height (twice the width).



Part numbers shown reflect common sizes. For additional options, follow the part number logic below or contact your Fypon® representative.

**SH2PC12X24RS**

<p><b>[Profile]</b> SH = Shutter</p>	<p><b>[Texture]</b> RS = Rough Sawn, Stain or Paint</p>	<p><b>[Height]</b> (1" increments) 24 = 24" [Minimum] 120 = 120" [Maximum]</p>
<p><b>[Configuration]</b> 2PC = 2-Board, 2-Batten 2P3BC = 2-Board, 3-Batten 2PHLR = 2-Board Quarter 2PZC = 2-Board, Z-Batten 2PEBC = 2-Board, End Batten</p>	<p><b>[Width]</b> 12 = 12"</p>	

Note: Minimum height for Quarter Round shutters is double the width of the shutter.  
SH2PHLR12X24RS - 12" = width of shutter and 24" = height (twice the width).

## 12" Board & Batten Shutters

Rough Sawn Cedar

2-Board, 2-Batten		2-Board, 3-Batten		2-Board, End Batten	
Part Number		Part Number		Part Number	
	SH2PC12X24RS		SH2P3BC12X24RS		SH2PEBC12X24RS
	SH2PC12X36RS		SH2P3BC12X36RS		SH2PEBC12X36RS
	SH2PC12X48RS		SH2P3BC12X48RS		SH2PEBC12X48RS
	SH2PC12X60RS		SH2P3BC12X60RS		SH2PEBC12X60RS
	SH2PC12X72RS		SH2P3BC12X72RS		SH2PEBC12X72RS
	SH2PC12X84RS		SH2P3BC12X84RS		SH2PEBC12X84RS
	SH2PC12X96RS		SH2P3BC12X96RS		SH2PEBC12X96RS
	SH2PC12X108RS		SH2P3BC12X108RS		SH2PEBC12X108RS
	SH2PC12X120RS		SH2P3BC12X120RS		SH2PEBC12X120RS

## 12" Board & Batten Shutters

Rough Sawn Cedar

2-Board, Z-Batten		2-Board, Quarter Round	
Part Number		Part Number	
	SH2PZC12X24RS		SH2PHLR12X24RS
	SH2PZC12X36RS		SH2PHLR12X36RS
	SH2PZC12X48RS		SH2PHLR12X48RS
	SH2PZC12X60RS		SH2PHLR12X60RS
	SH2PZC12X72RS		SH2PHLR12X72RS
	SH2PZC12X84RS		SH2PHLR12X84RS
	SH2PZC12X96RS		SH2PHLR12X96RS
	SH2PZC12X108RS		SH2PHLR12X108RS
	SH2PZC12X120RS		SH2PHLR12X120RS

Note: Shutters are sold as a set.  
Parts may be required to ship LTL (less than truckload) based on size and overall dimensions.



Part numbers shown reflect common sizes. For additional options, follow the part number logic below or contact your Fypon® representative.

**SH3PC14X24RS**

<p><b>[Profile]</b> SH = Shutter</p>	<p><b>[Texture]</b> RS = Rough Sawn, Stain or Paint</p>	
<p><b>[Configuration]</b>                  3PC = 3-Board, 2-Batten                  3P3BC = 3-Board, 3-Batten                  3PHLR = 3-Board Quarter                  3PZC = 3-Board, Z-Batten                  3PEBC = 3-Board, End Batten</p>	<p><b>[Height] (1" increments)</b>                  24 = 24" [Minimum]                  120 = 120" [Maximum]</p>	<p><b>[Width]</b>                  14 = 14"</p>

Note: Minimum height for Quarter Round shutters is double the width of the shutter.  
 Example: SH3PHLR14X28RS - 14" = width of shutter and 28" = height (twice the width).

## 14" Board & Batten Shutters

Rough Sawn Cedar

3-Board, 2-Batten	3-Board, 3-Batten	3-Board, End Batten
Part Number	Part Number	Part Number
SH3PC14X24RS	SH3P3BC14X24RS	SH3PEBC14X24RS
SH3PC14X36RS	SH3P3BC14X36RS	SH3PEBC14X36RS
SH3PC14X48RS	SH3P3BC14X48RS	SH3PEBC14X48RS
SH3PC14X60RS	SH3P3BC14X60RS	SH3PEBC14X60RS
SH3PC14X72RS	SH3P3BC14X72RS	SH3PEBC14X72RS
SH3PC14X84RS	SH3P3BC14X84RS	SH3PEBC14X84RS
SH3PC14X96RS	SH3P3BC14X96RS	SH3PEBC14X96RS
SH3PC14X108RS	SH3P3BC14X108RS	SH3PEBC14X108RS
SH3PC14X120RS	SH3P3BC14X120RS	SH3PEBC14X120RS

## 14" Board & Batten Shutters

Rough Sawn Cedar

3-Board, Z-Batten	3-Board, Quarter Round
Part Number	Part Number
SH3PZC14X24RS	—
SH3PZC14X36RS	SH3PHLR14X36RS
SH3PZC14X48RS	SH3PHLR14X48RS
SH3PZC14X60RS	SH3PHLR14X60RS
SH3PZC14X72RS	SH3PHLR14X72RS
SH3PZC14X84RS	SH3PHLR14X84RS
SH3PZC14X96RS	SH3PHLR14X96RS
SH3PZC14X108RS	SH3PHLR14X108RS
SH3PZC14X120RS	SH3PHLR14X120RS

Note: Shutters are sold as a set.  
 Parts may be required to ship LTL (less than truckload) based on size and overall dimensions.



Part numbers shown reflect common sizes. For additional options, follow the part number logic below or contact your **Fypon®** representative.

**SH3PC18X24RS**

<p><b>[Profile]</b> SH = Shutter</p>	<p><b>[Texture]</b> RS = Rough Sawn, Stain or Paint</p>	
<p><b>[Configuration]</b>  <b>3PC</b> = 3-Board, 2-Batten  <b>3P3BC</b> = 3-Board, 3-Batten  <b>3PHLR</b> = 3-Board Quarter  <b>3PZC</b> = 3-Board, Z-Batten  <b>3PEBC</b> = 3-Board, End Batten</p>	<p><b>[Height] (1" increments)</b>  <b>24</b> = 24" [Minimum]  <b>120</b> = 120" [Maximum]</p>	<p><b>[Width]</b>  <b>18</b> = 18"</p>

Note: Minimum height for Quarter Round shutters is double the width of the shutter.  
 Example: SH3PHLR18x36RS – 18" = width of shutter and 36" = height (twice the width).

## 18" Board & Batten Shutters

Rough Sawn Cedar

3-Board, 2-Batten	3-Board, 3-Batten	3-Board, End Batten
Part Number	Part Number	Part Number
SH3PC18X24RS	SH3P3BC18X24RS	SH3PEBC18X24RS
SH3PC18X36RS	SH3P3BC18X36RS	SH3PEBC18X36RS
SH3PC18X48RS	SH3P3BC18X48RS	SH3PEBC18X48RS
SH3PC18X60RS	SH3P3BC18X60RS	SH3PEBC18X60RS
SH3PC18X72RS	SH3P3BC18X72RS	SH3PEBC18X72RS
SH3PC18X84RS	SH3P3BC18X84RS	SH3PEBC18X84RS
SH3PC18X96RS	SH3P3BC18X96RS	SH3PEBC18X96RS
SH3PC18X108RS	SH3P3BC18X108RS	SH3PEBC18X108RS
SH3PC18X120RS	SH3P3BC18X120RS	SH3PEBC18X120RS

3-Board, Z-Batten	3-Board, Quarter Round
Part Number	Part Number
SH3PZC18X24RS	—
SH3PZC18X36RS	SH3PHLR18X36RS
SH3PZC18X48RS	SH3PHLR18X48RS
SH3PZC18X60RS	SH3PHLR18X60RS
SH3PZC18X72RS	SH3PHLR18X72RS
SH3PZC18X84RS	SH3PHLR18X84RS
SH3PZC18X96RS	SH3PHLR18X96RS
SH3PZC18X108RS	SH3PHLR18X120RS
SH3PZC18X120RS	SH3PHLR18X120RS

Note: Shutters are sold as a set.  
 Parts may be required to ship LTL (less than truckload) based on size and overall dimensions.



Part numbers shown reflect common sizes. For additional options, follow the part number logic below or contact your Fypon® representative.

**SH4PC24X24RS**



<p><b>[Profile]</b> SH = Shutter</p>	<p><b>[Texture]</b> RS = Rough Sawn, Stain or Paint</p>	
<p><b>[Configuration]</b>                  4PC = 4-Board, 2-Batten                  4P3BC = 4-Board, 3-Batten                  4PHLR = 4-Board Quarter                  4PZC = 4-Board, Z-Batten                  4PEBC = 4-Board, End Batten</p>	<p><b>[Height]</b> (1" increments)                  24 = 24" [Minimum]                  120 = 120" [Maximum]</p>	<p><b>[Width]</b>                  24 = 24"</p>

Note: Minimum height for Quarter Round shutters is double the width of the shutter.  
 Example: SH3PHLR24X48RS - 24" = width of shutter and 48" = height (twice the width).

## 24" Board & Batten Shutters

Rough Sawn Cedar

4-Board, 2-Batten	4-Board, 3-Batten	4-Board, End Batten
Part Number	Part Number	Part Number
 SH4PC24X24RS	 SH4P3BC24X24RS	 SH4PEBC24X24RS
SH4PC24X36RS	SH4P3BC24X36RS	SH4PEBC24X36RS
SH4PC24X48RS	SH4P3BC24X48RS	SH4PEBC24X48RS
SH4PC24X60RS	SH4P3BC24X60RS	SH4PEBC24X60RS
SH4PC24X72RS	SH4P3BC24X72RS	SH4PEBC24X72RS
SH4PC24X84RS	SH4P3BC24X84RS	SH4PEBC24X84RS
SH4PC24X96RS	SH4P3BC24X96RS	SH4PEBC24X96RS
SH4PC24X108RS	SH4P3BC24X108RS	SH4PEBC24X108RS
SH4PC24X120RS	SH4P3BC24X120RS	SH4PEBC24X120RS

4-Board, Z-Batten	4-Board, Quarter Round
Part Number	Part Number
 SH4PZC24X24RS	 —
SH4PZC24X36RS	—
SH4PZC24X48RS	SH4PHLR24X48RS
SH4PZC24X60RS	SH4PHLR24X60RS
SH4PZC24X72RS	SH4PHLR24X72RS
SH4PZC24X84RS	SH4PHLR24X84RS
SH4PZC24X96RS	SH4PHLR24X96RS
SH4PZC24X108RS	SH4PHLR24X108RS
SH4PZC24X120RS	SH4PHLR24X120RS

Note: Shutters are sold as a set.  
 Parts may be required to ship LTL (less than truckload) based on size and overall dimensions.

# 12" Plank Shutters

Rough Sawn Cedar

2-Plank, 2-Batten

2-Plank, 3-Batten

2-Plank, Z-Batten

Part Number	Part Number	Part Number
SH2P012X24RS	SH2P3B12X24RS	SH2PZ12X24RS
SH2P012X36RS	SH2P3B12X36RS	SH2PZ12X36RS
SH2P012X48RS	SH2P3B12X48RS	SH2PZ12X48RS
SH2P012X60RS	SH2P3B12X60RS	SH2PZ12X60RS
SH2P012X72RS	SH2P3B12X72RS	SH2PZ12X72RS
SH2P012X84RS	SH2P3B12X84RS	SH2PZ12X84RS
SH2P012X96RS	SH2P3B12X96RS	SH2PZ12X96RS
SH2P012X108RS	SH2P3B12X108RS	SH2PZ12X108RS
SH2P012X120RS	SH2P3B12X120RS	SH2PZ12X120RS

Part numbers shown reflect common sizes. For additional options, follow the part number logic below or contact your **Fypon®** representative.

## SH2P012X24RS

**[Profile]**  
SH = Shutter

**[Texture]**  
RS = Rough Sawn  
Stain or Paint

**[Configuration]**

2PO = 2-Plank, 2-Batten  
3PO = 3-Plank, 2-Batten  
4PO = 4-Plank, 2-Batten

2PZ = 2-Plank, Z-Batten  
3PZ = 3-Plank, Z-Batten  
4PZ = 4-Plank, Z-Batten

2P3B = 2-Plank, 3-Batten  
3P3B = 3-Plank, 3-Batten  
4P3B = 4-Plank, 3-Batten

**[Height]** (1" increments)  
24 = 24" [Minimum]  
120 = 120" [Maximum]

**[Width]**  
12 = 12"  
18 = 18"  
24 = 24"

# 18" Plank Shutters

Rough Sawn Cedar

3-Plank, 2-Batten

3-Plank, 3-Batten

3-Plank, Z-Batten

Part Number	Part Number	Part Number
SH3P018X24RS	SH3P3B18X24RS	SH3PZ18X24RS
SH3P018X36RS	SH3P3B18X36RS	SH3PZ18X36RS
SH3P018X48RS	SH3P3B18X48RS	SH3PZ18X48RS
SH3P018X60RS	SH3P3B18X60RS	SH3PZ18X60RS
SH3P018X72RS	SH3P3B18X72RS	SH3PZ18X72RS
SH3P018X84RS	SH3P3B18X84RS	SH3PZ18X84RS
SH3P018X96RS	SH3P3B18X96RS	SH3PZ18X96RS
SH3P018X108RS	SH3P3B18X108RS	SH3PZ18X108RS
SH3P018X120RS	SH3P3B18X120RS	SH3PZ18X120RS

# 24" Plank Shutters

Rough Sawn Cedar

4-Plank, 2-Batten

4-Plank, 3-Batten

4-Plank, Z-Batten

Part Number	Part Number	Part Number
SH4P024X24RS	SH4P3B24X24RS	SH4PZ24X24RS
SH4P024X36RS	SH4P3B24X36RS	SH4PZ24X36RS
SH4P024X48RS	SH4P3B24X48RS	SH4PZ24X48RS
SH4P024X60RS	SH4P3B24X60RS	SH4PZ24X60RS
SH4P024X72RS	SH4P3B24X72RS	SH4PZ24X72RS
SH4P024X84RS	SH4P3B24X84RS	SH4PZ24X84RS
SH4P024X96RS	SH4P3B24X96RS	SH4PZ24X96RS
SH4P024X108RS	SH4P3B24X108RS	SH4PZ24X108RS
SH4P024X120RS	SH4P3B24X120RS	SH4PZ24X120RS



### Additional Sizes Available

Shutters measuring 24" - 120", in 1" increments, are available at standard lead time.



## Elliptical Shutters - Board & Batten

Rough Sawn Cedar



### Part Number Logic:

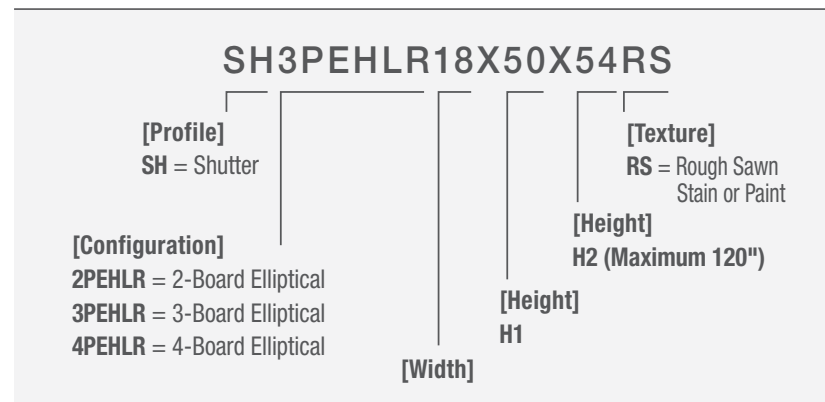

Note: Minimum height (H2) for Elliptical Board & Batten shutters is double the width of the shutter. Example: SH3PEHLR18X35X36RS - 18" = width of shutter and 36" = height (twice the width). If a specific radius is required to complement an elliptical-shaped window, contact your customer service representative to order.

## Elliptical Shutters - Plank

Rough Sawn Cedar



### Part Number Logic:

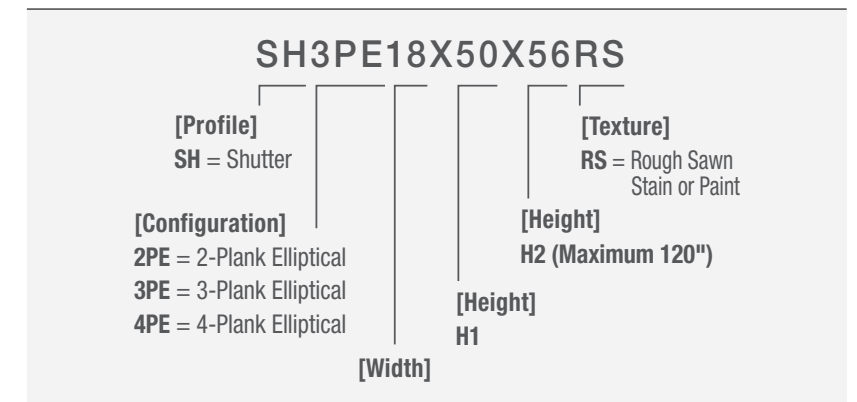

Note: Minimum height (H2) for Elliptical Board & Batten shutters is double the width of the shutter. Example: SH3PE18X35X36RS - 18" = width of shutter and 36" = height (twice the width). If a specific radius is required to complement an elliptical-shaped window, contact your customer service representative to order.

To order an Elliptical Board & Batten shutter that complements the arch of the window, provide measurements of **H1** (in 1/4" increments) and **H2** (in 1" increments) in your part number. See drawing for specific measurement points.

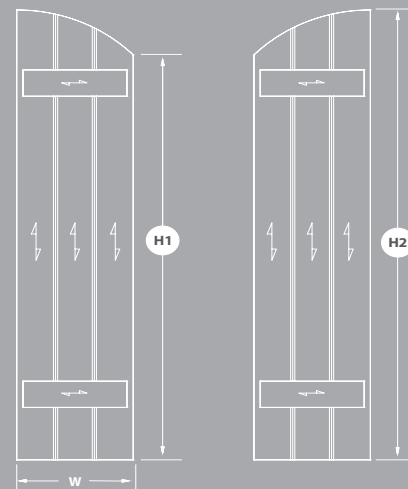

### Example:

SH3PEHLR18X50X54RS



To order an Elliptical Plank shutter that complements the arch of the window, provide measurements of **H1** (in 1/4" increments) and **H2** (in 1" increments) in your part number. See drawing for specific measurement points.

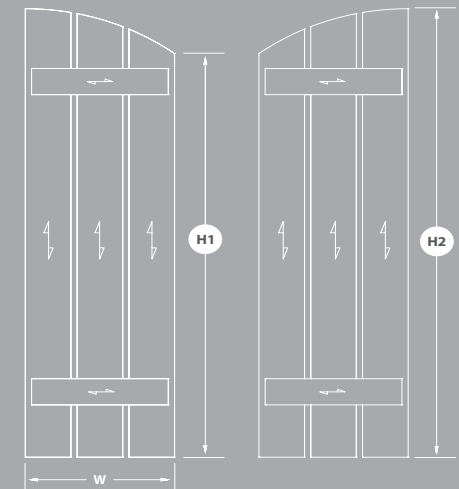

### Example:

SH3PE18X50X56RS





# Diamond Plank Shutters

Rough Sawn Cedar

2-Plank, Diamond

3-Plank, Diamond

4-Plank, Diamond

Part Number	Part Number	Part Number
SH2PD12X24RS	SH3PD18X24RS	SH4PD24X24RS
SH2PD12X36RS	SH3PD18X36RS	SH4PD24X36RS
SH2PD12X48RS	SH3PD18X48RS	SH4PD24X48RS
SH2PD12X60RS	SH3PD18X60RS	SH4PD24X60RS
SH2PD12X72RS	SH3PD18X72RS	SH4PD24X72RS
SH2PD12X84RS	SH3PD18X84RS	SH4PD24X84RS
SH2PD12X96RS	SH3PD18X96RS	SH4PD24X96RS
SH2PD12X108RS	SH3PD18X108RS	SH4PD24X108RS
SH2PD12X120RS	SH3PD18X120RS	SH4PD24X120RS



Part numbers shown reflect common sizes. For additional options, follow the part number logic below or contact your **Fypon®** representative.

## SH2PD12X24RS



## Wood-Grained Panel Shutter with Border



Part Number	Width	Height
SH3PB15X46S	15"	46"
SH3PB18X40S	18"	40"
SH3PB18X66S	18"	66"
SH3PB24X54S	24"	54"

Note: Shutters are sold as a set.



## Wood-Grained Shutter Board Fabrication Panels

Rough Sawn Cedar

	Individual Sheet Part Number	Width	Length	Thickness	Contractor Pack Part Number
	SHBB12X144RS 2-Board Panel	12"	144"	3/4"	SHBB12X144RS-CP*
	SHBB14X144RS 3-Board Panel	14"	144"	3/4"	SHBB14X144RS-CP*
	SHBB18X144RS 3-Board Panel	18"	144"	3/4"	SHBB18X144RS-CP*
	SHBB24X144RS 4-Board Panel	24"	144"	3/4"	SHBB24X144RS-CP*
	FLT1X4-12RS Batten Trim	3-1/2"	144"	3/4"	—

\*Sold in packs of 10.



## Shutter Accessories - Hinges

Colonial & Spear

	Part Number	Length		Part Number	Length
	SHHNGCOL10**	10"		SHHNGSPR10**	10"
	SHHNGCOL16**	16"		SHHNGSPR16**	16"

## Shutter Accessories - Clavos

Round & Pyramid

	Part Number	Diameter		Part Number	Width
	SHCLARND1.25**	1-1/4"		SHCLAPYR1.25**	1-1/4"
	SHCLARND1.25-8PACK	1-1/4"		SHCLAPYR1.25-8PACK	1-1/4"
	SHCLARND1.25-12PACK	1-1/4"		SHCLAPYR1.25-12PACK	1-1/4"
	SHCLARND1.25-18PACK	1-1/4"		SHCLAPYR1.25-18PACK	1-1/4"
	SHCLARND1.25-24PACK	1-1/4"		SHCLAPYR1.25-24PACK	1-1/4"
	SHCLARND1.25-100PACK	1-1/4"		SHCLAPYR1.25-100PACK	1-1/4"



\*\*Sold as a set.

Note: Shutter accessories come primed and ready for paint.

Parts may be required to ship LTL (less than truckload) based on size and overall dimensions.