

Balustrades, Porch Posts & Columns



- Balusters237
- Top Rails244
- Bottom Rails245
- Installation Aids246
- Newel Posts248
- Post Accessories.....250
- Porch Spandrels.....252
- Structural Column252
- Structural Porch Posts.....253
- Wood-Grained Column.....255
- Stone Balustrade System.....256
- Stone Half-Round Column257

ADD OUTDOOR SOPHISTICATION.

Transform any porch, patio or balcony into an impressive outdoor living area. An eye-catching accent for many home designs, our balustrades, porch posts and columns are beautiful and durable.

Product Shown:
 Square Baluster
 Top Straight Rail
 Bottom Straight Rail
 Plain Newel Post
 Flat Post Top
 Trim Collar
 Rail Support Block



Balustrades, Porch Posts & Columns

HOW TO ORDER

Balustrade Systems

Our smooth balustrades are available in three systems: 5", 7" and 12". This size designates the width of the top and bottom rail. In addition to these three sizes, we offer a stone-textured system, which has a 6" wide top and bottom rail.

Planning Your Layout

Balusters

For each baluster, we have noted a center spacing dimension. This is the maximum center-to-center distance between balusters that does not allow a 4" ball to pass through at any point. The number of balusters you need can be found by dividing the rail span, in inches, by the center spacing dimension shown under each part.

Note: When dividing gives you a fractional result, always round up to the next whole number as shown in the example.

Rail Installation Kits

Each rail section (span between two newel posts) will require two Rail Installation Kits. Rail Installation Kits will connect both ends of one rail to a newel post or column.

Note: Rail Installation Kits will not work on stair applications. Top and bottom rails do not come pre-drilled.

Newel Posts

Each newel post will require one Newel Post Installation Kit to anchor the base of the post, as well as any post tops, balls or trim collars desired.

Balustrade System Accessories

Balustrade system accessories are available to help achieve your desired look. All balustrade accessories are unattached and must be ordered separately.

Structural Porch Posts & Columns

Structural porch posts and columns are reinforced and have load-bearing capacities as noted. Installation hardware is included. Simply choose the column or porch post desired in a height that is equal to or slightly larger than the required height. Porch posts and columns can be trimmed to various lengths without impacting load rating. Be sure to order the appropriate quantity of porch posts and columns to adequately support the weight of the load they will carry.

Always consult the local building code authority to determine suitability of products to meet specific project requirements.



BALUSTER EXAMPLE

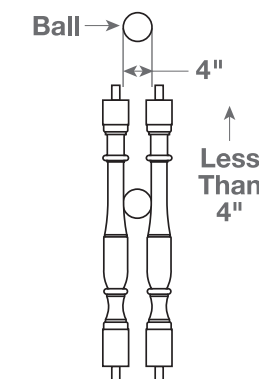

BAL3X20CC – Requires 5" on center spacing

Rail Span ÷ Center Spacing =
No. of Balusters Needed

$$96" \div 5" = 19.2$$

(Round up to 20)



Ashley Baluster

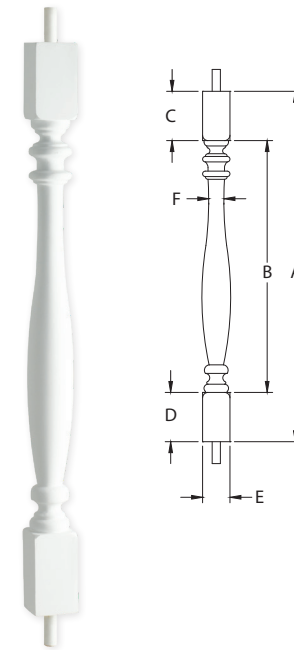

Part Number	Balustrade Rail System	A	B	C	D	E	F	Maximum Center-to-Center Distance
BAL2.5X15AY	5"	15"	9"	3"	3"	2-1/2"	1-7/8"	5-7/8"
BAL3X20AY	5"	20"	15"	2-1/2"	2-1/2"	2-1/2"	1-1/2"	5-3/8"
BAL3X24AY	5"	24"	15"	4-1/2"	4-1/2"	2-1/2"	1-3/8"	5-3/8"
BAL3X28AY	5"	28"	19"	4-1/2"	4-1/2"	2-1/2"	1-3/8"	5-3/8"
BAL3X32AY	5"	32"	23"	4-1/2"	4-1/2"	2-1/2"	1-3/8"	5-3/8"
BAL3X36AY	5"	36"	24"	6"	6"	2-1/2"	1-1/4"	5-1/4"
BAL4X24AY	7"	24"	15"	4-1/2"	4-1/2"	4-1/2"	3-1/2"	7-3/8"
BAL5X24AY	7"	24"	17"	3-1/2"	13-1/2"	4-1/2"	3-1/2"	7-3/8"
BAL5X32AY	7"	32"	23"	4-1/2"	4-1/2"	4-1/2"	3-3/8"	7-3/8"

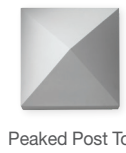
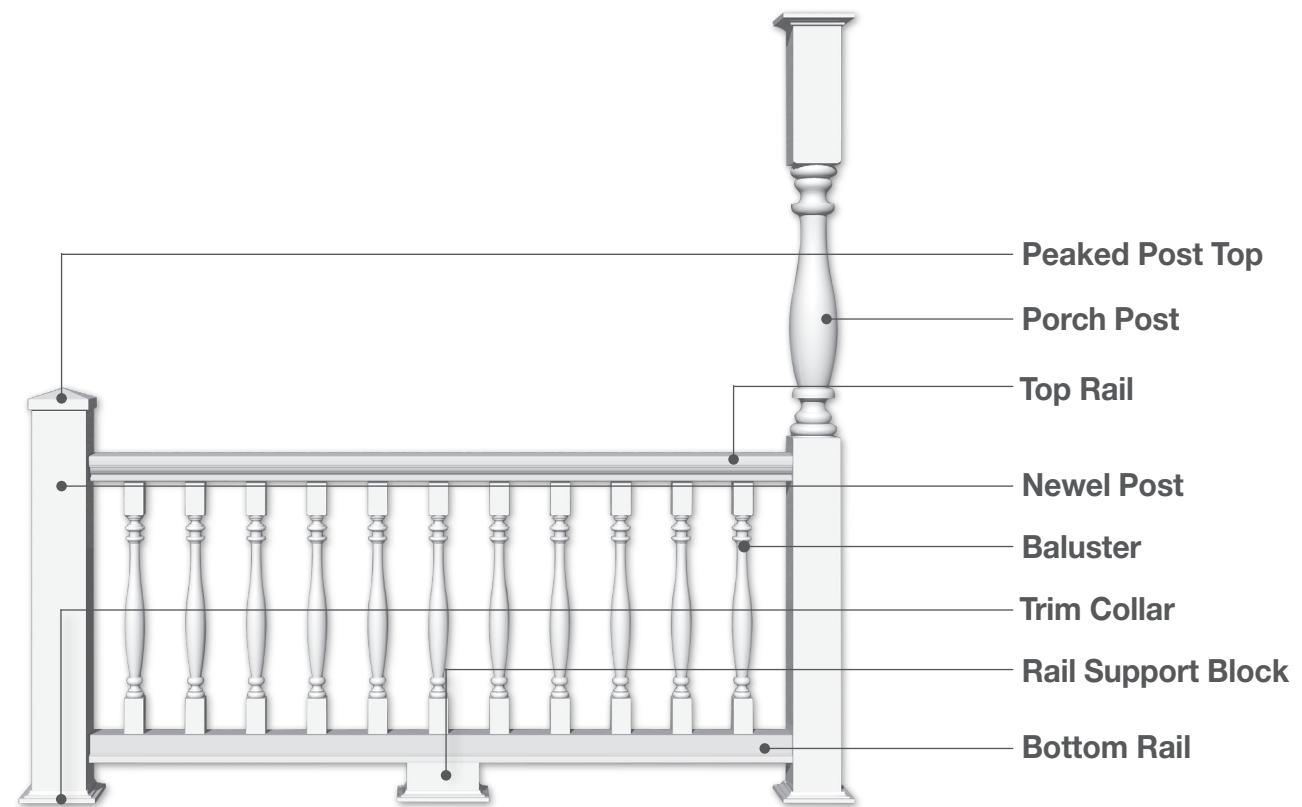

Peaked Post Top



Trim Collar



Baluster Reinforced

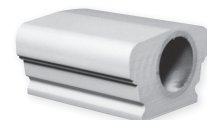

Top Rail Reinforced

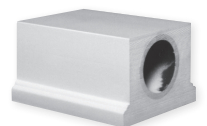

Bottom Rail Reinforced

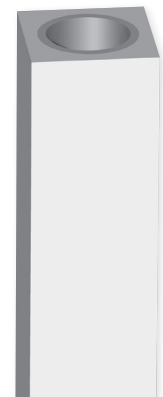

Newel Post Reinforced



Load-Bearing Porch Post Reinforced



Rail Support Block



Note: Made of polyurethane material.
 Note: Baluster images shown may not be an accurate representation of every size within each category. For additional line art images, visit fypon.com.
 Parts may be required to ship LTL (less than truckload) based on size and overall dimensions.



Classic Baluster

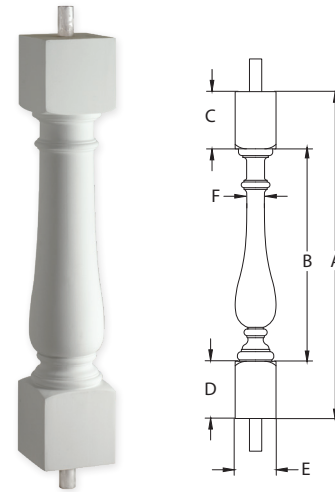

Part Number	Balustrade Rail System	A	B	C	D	E	F	Maximum Center-to-Center Distance
BAL3X20CC	5"	20"	13"	3-1/2"	3-1/2"	2-1/2"	1-1/8"	5"
BAL3X24CC	5"	24"	17"	3-1/2"	3-1/2"	2-1/2"	1-1/8"	5"
BAL3X28CC	5"	28"	21"	3-1/2"	3-1/2"	2-1/2"	1"	5"
BAL3X32CC	5"	32"	25"	3-1/2"	3-1/2"	2-1/2"	1-1/8"	5-1/8"
BAL5X20CC	7"	20"	10"	5"	5"	5"	3-5/8"	7-5/8"
BAL5X24CC	7"	24"	14"	5"	5"	5"	3-5/8"	7-5/8"
BAL5X28CC	7"	28"	18"	5"	5"	5"	3-1/2"	7-1/2"
BAL5X30CC	7"	30-1/2"	20-1/2"	5"	5"	5"	3-5/8"	7-1/2"
BAL5X32CC	7"	32"	22"	5"	5"	5"	3-1/2"	7-1/2"
BAL4X27CCOB	7"	27"	19"	4"	4"	4-1/4"	1-7/8"	5-3/4"
BAL4X31CCOB	7"	31"	23"	4"	4"	4-1/4"	1-1/2"	5-3/4"
BAL5X28CCOB	7"	28"	21-1/8"	3-3/8"	3-3/8"	4-1/2"	2"	5-7/8"
BAL7X28CC	12"	28"	16"	6"	6"	7"	5-1/2"	9-3/8"
BAL7X28CCOB	12"	28"	21-1/4"	3-5/8"	3-3/8"	7"	3-5/8"	7-1/2"



Beaumont Baluster

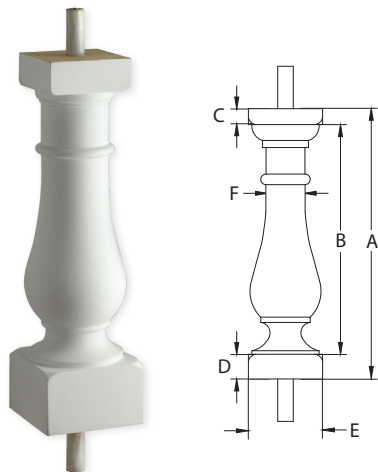

Part Number	Balustrade Rail System	A	B	C	D	E	F	Maximum Center-to-Center Distance
BAL4X22BE	7"	22"	19-1/8"	1-1/8"	1-3/4"	4"	2-3/8"	6-1/4"
BAL5X19BE	7", 12"	19-1/8"	16-1/4"	1-1/8"	1-3/4"	5-1/4"	2-3/4"	6-3/4"
BAL5X22BE	7", 12"	22"	16-1/8"	2-1/8"	3-3/4"	5"	3-1/4"	7-1/8"
BAL5X31BE	12"	31"	24-7/16"	2-1/2"	4-1/8"	5-3/4"	2-7/8"	6-1/8"
BAL6X22BE	12"	21-7/8"	16-1/8"	2-1/8"	3-3/4"	6-1/4"	4"	8"

Note: Baluster images shown may not be an accurate representation of every size within each category. For additional line art images, visit fypon.com. Parts may be required to ship LTL (less than truckload) based on size and overall dimensions.

Logan Baluster

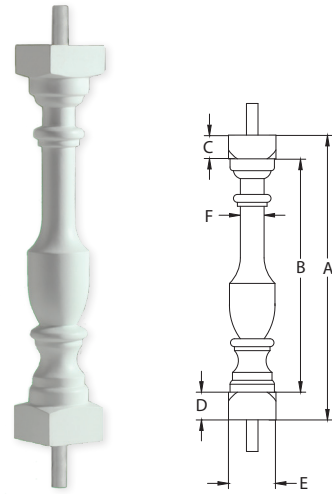

Part Number	Balustrade Rail System	A	B	C	D	E	F	Maximum Center-to-Center Distance
BAL3X24LN	5"	24"	18"	3"	3"	3"	1-1/2"	5-1/2"
BAL3X28LN	5"	28"	22"	3"	3"	3"	1-1/2"	5-1/2"

Woodruff Baluster

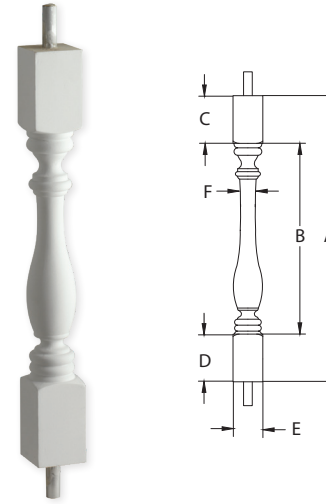

Part Number	Balustrade Rail System	A	B	C	D	E	F	Maximum Center-to-Center Distance
BAL3X18WF	5"	18"	10"	4"	4"	2-1/2"	1-3/8"	5-1/2"
BAL3X20WF	5"	20"	12"	4"	4"	2-1/2"	1-1/4"	5-1/4"
BAL3X24WF	5"	24"	16"	4"	4"	2-1/2"	1-1/4"	5-1/8"
BAL3X28WF	5"	28"	20"	4"	4"	2-1/2"	1-1/4"	5-1/8"
BAL3X32WF	5"	32"	24"	4"	4"	2-1/2"	1-1/4"	5-1/8"
BAL3X36WF	5"	36"	28"	4"	4"	2-1/2"	1-1/2"	5-1/8"
BAL5X24WF	7", 12"	24"	16"	4"	4"	4-1/2"	3-1/4"	7-1/8"
BAL5X28WF	7", 12"	28"	20"	4"	4"	4-1/2"	3-1/2"	7-1/8"
BAL5X32WF	7", 12"	32"	24"	4"	4"	4-1/2"	3-1/2"	7-1/8"

Rosedale Baluster

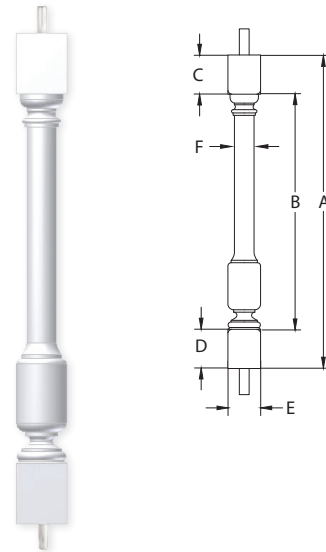

Part Number	Balustrade Rail System	A	B	C	D	E	F	Maximum Center-to-Center Distance
BAL5X20RL	7", 12"	20"	12"	4"	4"	4-1/2"	2-3/4"	6-5/8"



Note: Baluster images shown may not be an accurate representation of every size within each category. For additional line art images, visit fypon.com. Parts may be required to ship LTL (less than truckload) based on size and overall dimensions.

Square Baluster

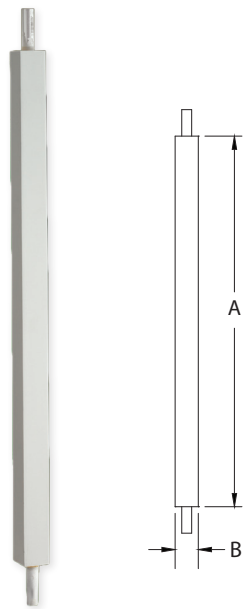



Part Number	Balustrade Rail System	Height (A)	Width (B)	Maximum Center-to-Center Distance
BAL2X20SQ	5"	20"	1-3/4"	5-3/4"
BAL2X24SQ	5"	24"	1-3/4"	5-3/4"
BAL2X28SQ	5"	28"	1-3/4"	5-3/4"
BAL2X32SQ	5"	32"	1-3/4"	5-3/4"



Note: Baluster images shown may not be an accurate representation of every size within each category. For additional line art images, visit fypon.com. Parts may be required to ship LTL (less than truckload) based on size and overall dimensions.

Top Straight Rails

Top Rail	Part Number	Balustrade Rail System	Length	A	B	C
	BTR5X96	5"	96"	3-1/4"	3-1/8"	4-5/8"
	BTR5X144*	5"	144"	3-1/4"	3-1/8"	4-5/8"
	BTR7X96	7"	96"	5-1/2"	5-1/4"	7"
	BTR7X120*	7"	120"	5-1/2"	5-1/4"	7"
	BTR7X144*	7"	144"	5-1/2"	5-1/4"	7"

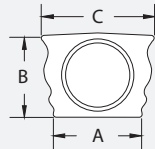
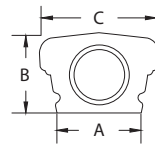

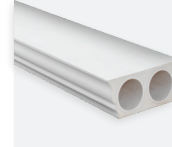

Top Straight Rails

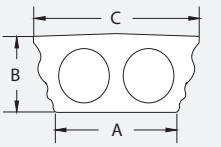
Top Rail	Part Number	Balustrade Rail System	Length	A	B	C
	BTR12X96	12"	96"	9"	5-1/4"	11-7/8"
	BTR12X120*	12"	120"	9"	5-1/4"	11-7/8"
	BTR12X144*	12"	144"	9"	5-1/4"	11-7/8"

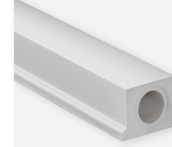

Bottom Straight Rails

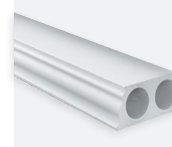

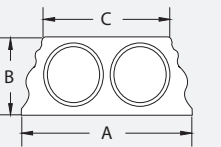
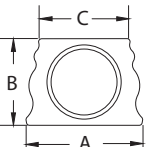
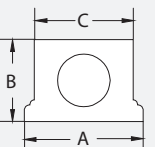

Bottom Rail	Part Number	Balustrade Rail System	Length	A	B	C
	BBR5X96	5"	96"	4-1/2"	3-1/8"	3-3/4"
	BBR5X144*	5"	144"	4-1/2"	3-1/8"	3-3/4"
	BBR7X96	7"	96"	7"	5-1/4"	5-1/2"
	BBR7X120*	7"	120"	7"	5-1/4"	5-1/2"
	BBR7X144*	7"	144"	7"	5-1/4"	5-1/2"
	BBR12X96	12"	96"	11-7/8"	5-1/4"	9"
	BBR12X120*	12"	120"	11-7/8"	5-1/4"	9"
	BBR12X144*	12"	144"	11-7/8"	5-1/4"	9"



*Maximum rail span distance for field applications is 96".
Parts may be required to ship LTL (less than truckload) based on size and overall dimensions.

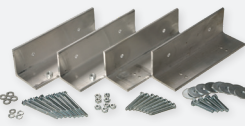

Balustrade Rail Installation Aids

Part Number	Balustrade System	Installation Notes
 RSB4X4X6 Rail Support Block	5", 7", 12"	Install under the bottom rail at a span of 48" or less. Dimensions: 4" x 4" x 7-1/4" (may be trimmed for height). 
 BRK5 Rail Installation Kit	5"	Connects both ends of one 5" top or bottom rail to support structure. Order two kits per section. Kit Contents: (2) Angle Brackets & Mounting Hardware
 BRK6-7 Rail Installation Kit	7"	Connects both ends of one 7" top or bottom rail to support structure. Order two kits per section. Kit Contents: (2) Angle Brackets & Mounting Hardware
 BRK12 Rail Installation Kit	12"	Connects both ends of one 12" top or bottom rail to 12" newel post or other support. Order two kits per section. Kit Contents: (2) Bear Claw Brackets & Mounting Hardware
 BRK12ANGLBKT Rail Installation Kit	12"	Connects both ends of one 12" top or bottom rail to 13" newel post only. Order two kits per section. Kit Contents: (4) Angle Brackets & Mounting Hardware

Plain Newel Post

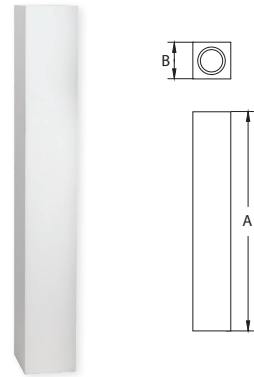

Part Number	Balustrade System	A	B	Accessories	Installation Kit
NP6X48	5"	48"	5-1/2"	PST6X6FP PST7X7F TC6	NPK400
NP8X48	7"	48"	7-1/2"	PST8X8FP PST10X10F TC8	NPK600

Decorative Newel Post

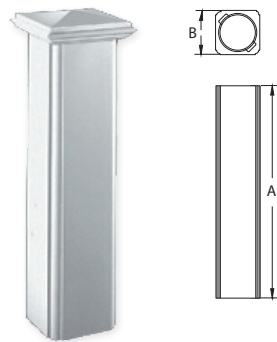

Part Number	Balustrade System	A	B	Accessories	Installation Kit
NP10X48	7"	48"	10"	PST11X11FP	NPK10



Corner Panel Newel Post

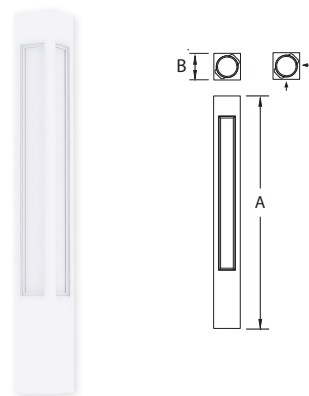

Part Number	Balustrade System	A	B	Accessories	Installation Kit
NPCP8X48	7"	48"	8"	PST9X9FP PST10X10F TC8-8	NPK600
NPCP13X48	12"	48"	12-1/2"	PST13X13FP PST14X14F	NPK13

Straight Panel Newel Post

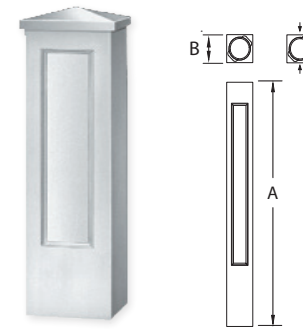

Part Number	Balustrade System	A	B	Accessories	Installation Kit
NPSP8X48	7"	48"	8"	PST9X9FP PST10X10F TC8-8	NPK600
NPSP13X48	12"	48"	12-1/2"	PST13X13FP PST14X14F	NPK13

Plain Three-Piece Newel Post

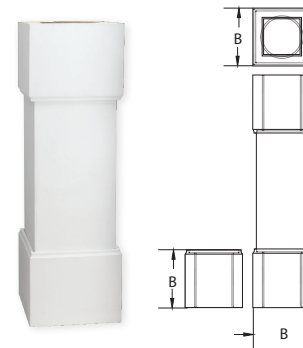

Part Number	Balustrade System	A	B	Accessories	Installation Kit
NP12X48	12"	48"	12"	PST13X13F PST13X13FP	NPK12

Newel Post Installation Kits

Newel Post Installation Kits are sold separately from the newel posts. Fasteners to mount steel base plate to the floor surface are not provided.

Installation Kit	Kit Contents
NPK10	Secures one 10" newel post to the structural substrate.
NPK12	Secures one 12" newel post to the structural substrate.
NPK13	Secures one 13" newel post to the structural substrate.
NPK400	Secures one 6" newel post to the structural substrate.
NPK600	Secures one 8" newel post to the structural substrate.

Note: Post tops shown are sold separately.
Parts may be required to ship LTL (less than truckload) based on size and overall dimensions.

Post Accessories

Part Number	Balustrade System	Bottom Width (A)	Top Width (B)	Height (C)	Accessories
-------------	-------------------	------------------	---------------	------------	-------------



B5X7
Ball Top

5", 7"

4-3/8"

5-1/4"

6-3/4"

PST7X7F

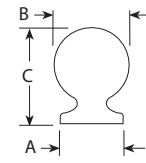

B10X13
Ball Top

12"

8-1/2"

10"

12-7/8"

PST13X13F
PST14X14F

Part Number	Balustrade System	Bottom Width (A)	Top Width (B)	Height (C)	Accessories
PST7X7F Flat Post Top	5"	6-1/2"	4-1/2"	1-1/2"	NP6X48
PST10X10F Flat Post Top	7"	9-1/2"	6-1/4"	2"	NP8X48 NPCP8X48 NPSP8X48
PST13X13F Flat Post Top	12"	12-1/2"	8-5/8"	1-1/2"	B10X13 NP12X48
PST14X14F Flat Post Top	12"	14"	8-3/4"	3-1/8"	B10X13 NPCP13X48 NPSP13X48

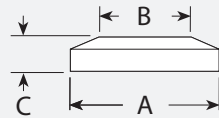

Post Accessories

Part Number	Balustrade System	Bottom Width (A)	Top Width (B)	Height (C)	Accessories
-------------	-------------------	------------------	---------------	------------	-------------

PST6X6FP
Fancy Peaked Top

5"

5-7/8"

—

2-1/8"

NP6X48

PST8X8FP
Fancy Peaked Top

7"

8-1/8"

—

3"

NP8X48

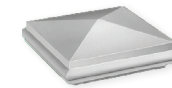

PST9X9FP
Fancy Peaked Top

7"

8-7/8"

—

3"

NPCP8X48
NPSP8X48



PST11X11FP
Fancy Peaked Top

7"

10-3/4"

—

4-1/2"

—

PST13X13FP
Fancy Peaked Top

12"

13-1/4"

—

4-5/8"

NP12X48
NPCP13X48
NPSP13X48



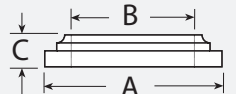

Part Number	Balustrade System	Bottom Width (A)	Top Width (B)	Height (C)	Accessories
TC6 Trim Collar	5"	9-1/8"	5-5/8"	2"	NP6X48
TC8 Trim Collar	7"	11-1/8"	7-5/8"	2"	NP8X48
TC8-8 Trim Collar	7"	11-1/8"	8-1/8"	2"	NP8X48





Porch Spandrels

Part Number	Length (A)	Height (B)	Projection (C)	Design Repeat (D)
 PRS48X8	48"	7-3/4"	1"	5-1/4"
 PRS96X8	97-1/2"	8-1/4"	2-7/8"	8-1/8"

Panel Square Column

Structural

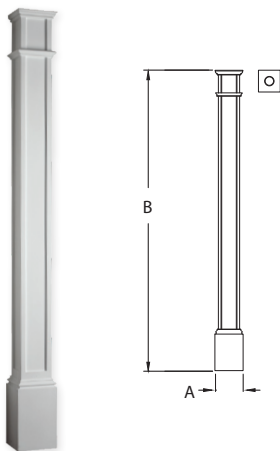

Part Number	Width	Base Width (A)	Height (B)	Base Height	Load-Bearing Capacity
COL8X96PSQ*	6-1/8"	8"	96"	13-5/8"	12,000#
COL11X96PSQ*	8"	10-1/2"	96"	13-3/4"	12,000#
COL11X108PS*	8"	10-5/8"	108"	12-3/4"	12,000#

Vintage Porch Post

Structural

Part Number	Width (A)	Overall Height (B)	Bottom Block Height (C)	Load-Bearing Capacity	Balustrade System
PP8X120A*	7-1/2"	120"	42"	12,000#	7"

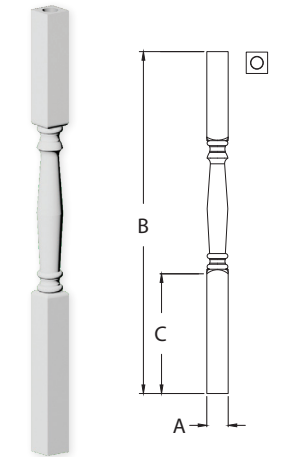

Colonial Porch Post

Structural

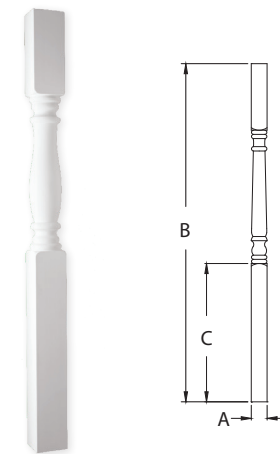

Part Number	Width (A)	Overall Height (B)	Bottom Block Height (C)	Load-Bearing Capacity	Balustrade System
PP5X102*	4-3/4"	101-1/4"	41-1/2"	6,000#	5"
PP6X96*	5-1/2"	96"	44-1/2"	6,000#	5"
PP6X108*	5-1/2"	108"	44-1/2"	6,000#	5"
PP6X120*	5-1/2"	120"	44-1/2"	6,000#	5"

Lamp Post

Non-Structural / Decorative

Part Number	Bottom Width (A)	Top Width (B)	Height (C)	Pipe Diameter
LP6X96**	5-1/2"	3-1/2"	96"	2-7/8"

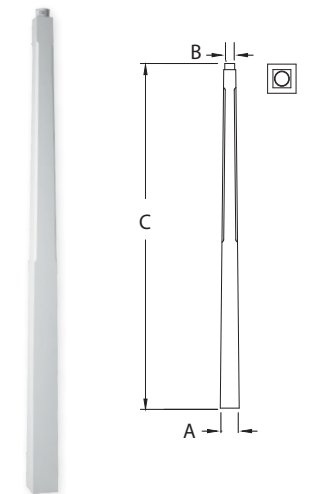

*Installation kit included.

**Non-structural pipe extends 1-3/4" beyond top of post.

Note: Porch posts can be field trimmed to various heights without losing load rating.

Parts may be required to ship LTL (less than truckload) based on size and overall dimensions.



Structural Wood-Grained Column

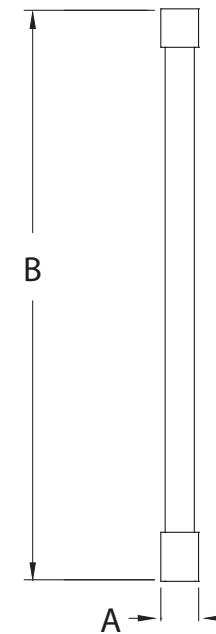

Part Number	Width (A)	Height (B)	Load Bearing Capacity
PPSQKIT6X108S*	7"	108"	12,000#



*Installation kit included. Column can be field trimmed to various heights without losing load rating. Cap is 9-5/8" x 7" and base is 9-5/8" x 9". Parts may be required to ship LTL (less than truckload) based on size and overall dimensions.

Stone Euro Baluster

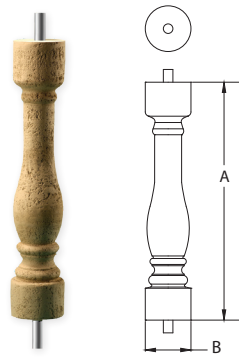

Part Number	Height (A)	Width (B)	Maximum Center-to-Center Distance
BAL5X28EUST*	27-7/8"	5-3/8"	7-5/8"

Stone Rails

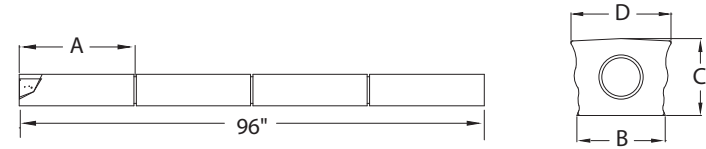

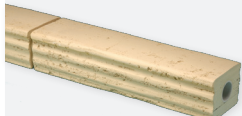
	Part Number	Length	Molded Rail Section (A)	Width (B)	Height (C)	Overall Width (D)
 Top	BTR6X96ST	96"	23-7/8"	5-3/4"	5"	6-1/2"
 Bottom	BBR6X96ST	96"	23-7/8"	5-5/8"	4-7/8"	6-1/4"



Stone Newel Post

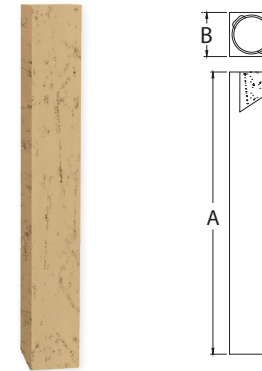

Part Number	A	B	Installation Kit	Accessories
NP8X48ST	48"	7-1/2"	NPK600	PST10X10PST

Stone Post Cap

Part Number	A	B
 PST10X10PST	9-1/2"	3"

Stone Half-Round Column

Non-Structural / Decorative

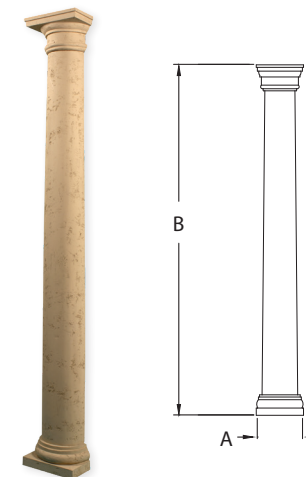

Part Number	Width (A)	Height (B)	Projection
HRCBCC96X12ST Tapered Kit Kit ships in 3 pieces and creates one half column. Order two kits to create a full column.	15"	110-1/4"	11-3/4"
Kit Contents: (1) Cap Half [CC15ST] (1) Shaft Half [HRCB96X12ST] (1) Base Half [CB15ST]			

*1-1/8" X 30-3/4" fiberglass pipe molded into baluster.

Note: Always consult the local building code authority to determine suitability of products to meet specific requirements, as well as adhesive manufacturer's recommendations for your particular climate and the substrate you are installing to.

Parts may be required to ship LTL (less than truckload) based on size and overall dimensions.